



Progress of Injector Linac

Kazuro Furukawa
for Injector Linac



- ◆ 入射器の復習
- ◆ 今期の運転
- ◆ Alignment
- ◆ 陽電子発生装置
- ◆ RF 電子銃
- ◆ Commissioning
- ◆ Phase-1 定常運転

Mission of electron/positron Injector in SuperKEKB

◆ 40-times higher Luminosity

❖ Twice larger storage beam

→ Higher beam current at Linac

❖ 20-times higher collision rate with nano-beam scheme

✧ → Low-emittance even at first turn

→ Low-emittance beam from Linac

✧ → Shorter storage lifetime

→ Higher Linac beam current

◆ Linac challenges

❖ Low emittance e^-

✧ with high-charge RF-gun

❖ Low emittance e^+

✧ with damping ring

❖ Higher e^+ beam current

✧ with new capture section

❖ Emittance preservation

✧ with precise beam control

❖ 4+1 ring simultaneous injection

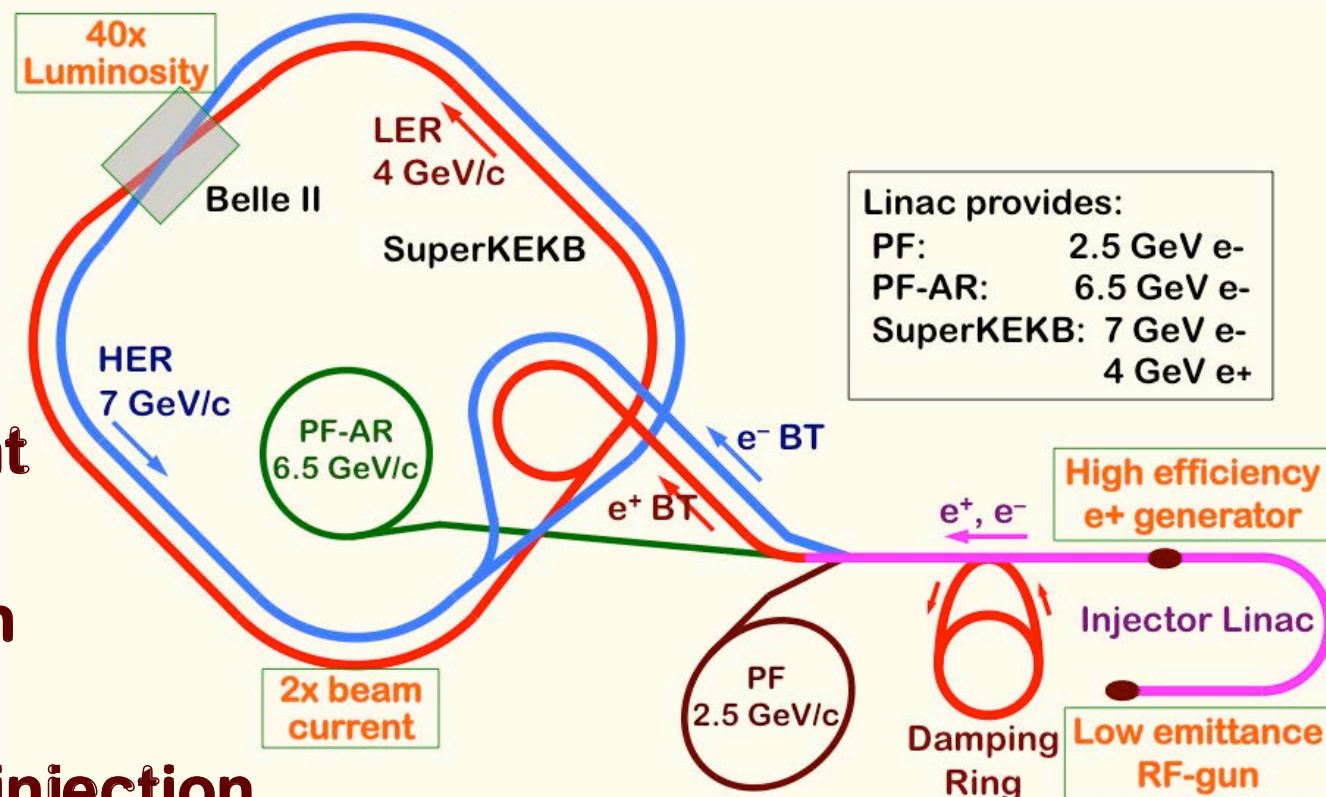



電子ビームパラメータ

	SuperKEKB	KEKB
エネルギー (GeV)	7.0	8.0
HER蓄積電流値 (A)	2.6	1.1
HERビーム寿命 (min.)	6	200
最大ビーム繰り返し (Hz)	50	50
最大バンチ数 (rfパルス当たり)	2	2
エミッタンス (mm·mrad)	50/20 (Hor./Ver.)	100
バンチ電荷量 (nC)	5	1
エネルギー広がり (%)	0.1	0.05
バンチ長 σ_z (mm)	1.3	1.3
ダンピングリング	n/a	n/a
同時トップアップ入射	4 rings (SuperKEKB e-/e+, PF, PF-AR)	3 rings (KEKB e-/e+, PF)



陽電子ビームパラメータ

	SuperKEKB	KEKB
エネルギー (GeV)	4	3.5
LER蓄積電流値 (A)	3.6	1.6
LERビーム寿命 (min.)	6	133
最大ビーム繰り返し (Hz)	50	50
最大バンチ数 (rfパルス当たり)	2	2
エミッタンス (mm·mrad)	100/20 (Hor./Ver.)	2100
バンチ電荷量 (nC)	4	1
エネルギー広がり (%)	0.1	0.125
バンチ長 σ_z (mm)	0.7	2.6
ダンピングリング	○	n/a
同時トップアップ入射	4 rings (SuperKEKB e-/e+, PF, PF-AR)	3 rings (KEKB e-/e+, PF)



Linac Schedule Overview (tentative A)

RF-Gun e- beam commissioning at A,B-sector

e- commiss. at A,B,J,C,1

e+ commiss. at 1,2 sector (FC, DCS, Qe- 50%)
e- commiss. at 1,2,3,4,5 sector

Phase1: high emittance beam for vacuum scrub
Phase2,3: low emittance beam for collision

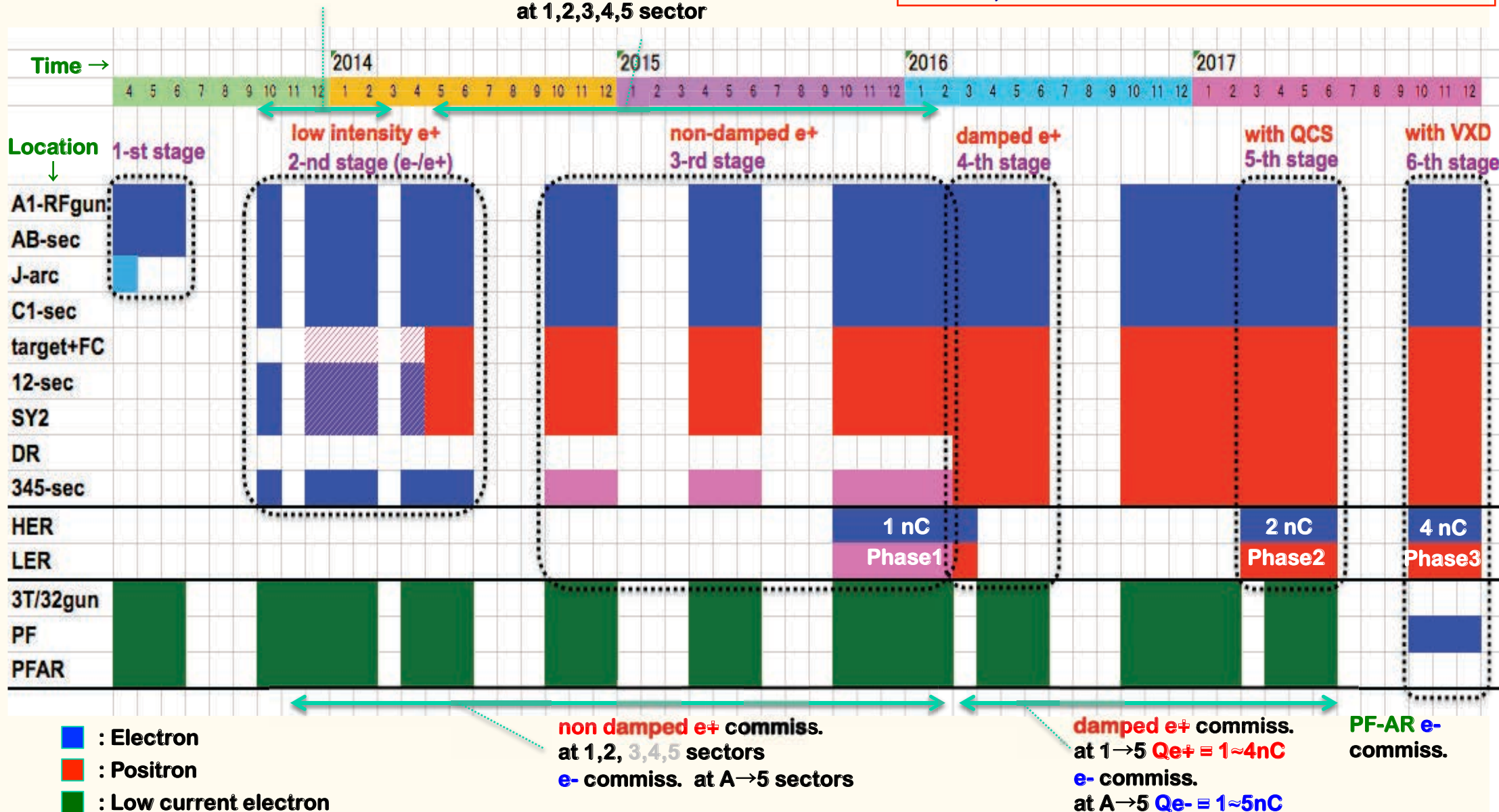



Linac Schedule Overview (tentative B)

RF-Gun e- beam commissioning at A,B-sector

e- commiss. at A,B,J,C,1

e+ commiss. at 1,2 sector (FC, DCS, Qe- 50%)
e- commiss. at 1,2,3,4,5 sector

Phase1: high emittance beam for vacuum scrub
Phase2,3: low emittance beam for collision

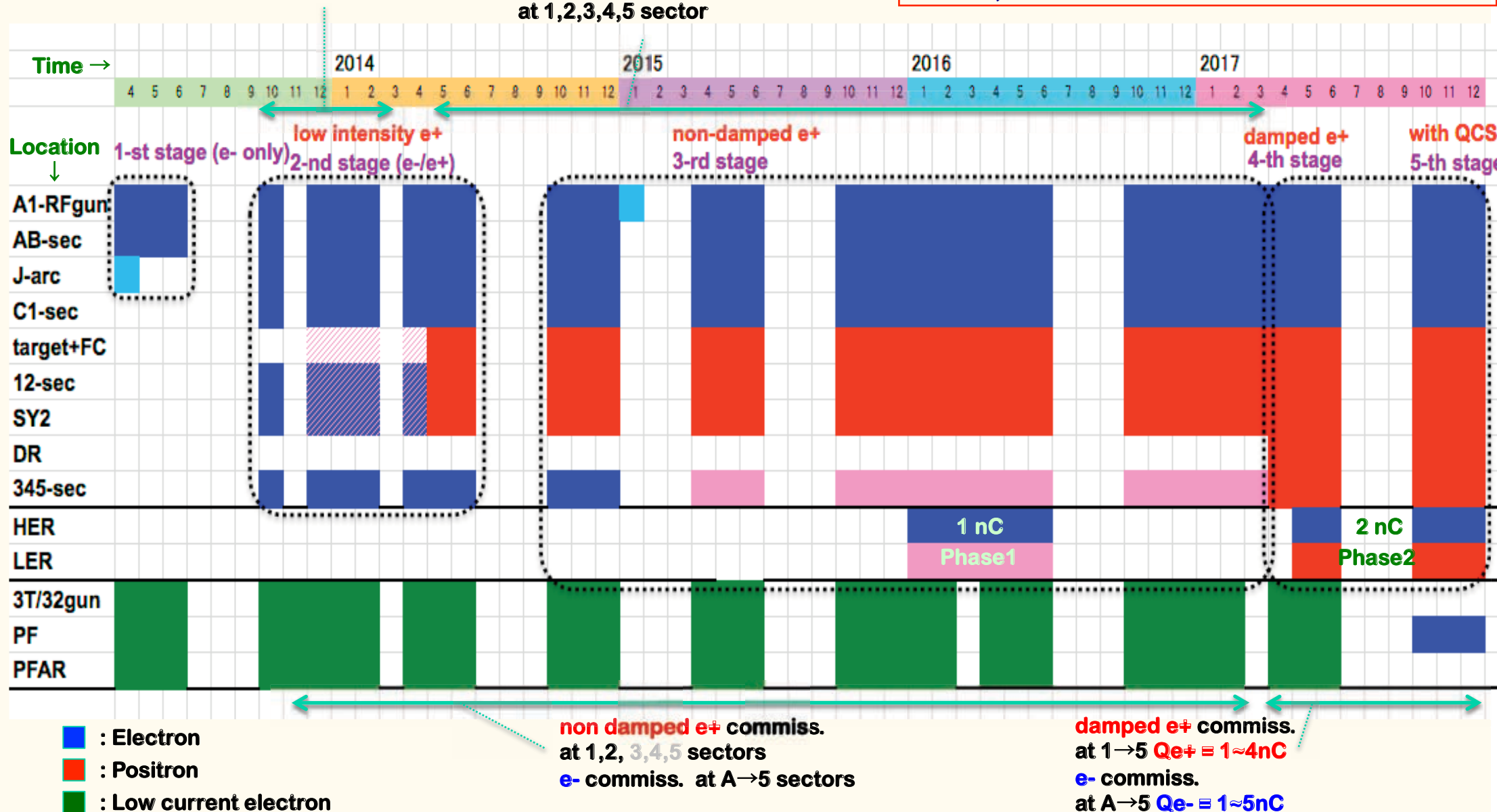

Operation Status

◆ FY2014 の運転

❖ **運転時間: 3900 hours (FY2013 -27%)**

❑ **PF/PF-AR Injection (and Commissioning for SuperKEKB)**

❑ **Apr.11 – Apr.25**

❑ **May.7 – Jul.1**

❑ **Sep.24 – Dec.26**

❑ **5 days in Jan, Feb**

❖ **故障 (FY2013 0.43%)**

❑ **偏向電磁石コイル発熱 (May)**

❑ **マイクロ波パルス電源デスバイカー発熱 (May)**

❑ **フラックスコンセントレータ電源側ケーブル発熱 (Dec)**

❑ **マイクロ波パルス電源トランス端末発熱 (Dec)**



Facility for Electric Power and Cooling Water

- ◆ Linac needs electricity and cooling water extensions, especially for positron generator upgrade
- ◆ Separate building construction in FY2013 not to impact PF/PF-AR
- ◆ Facility extensions performed during summer 2014

SuperKEKB injector

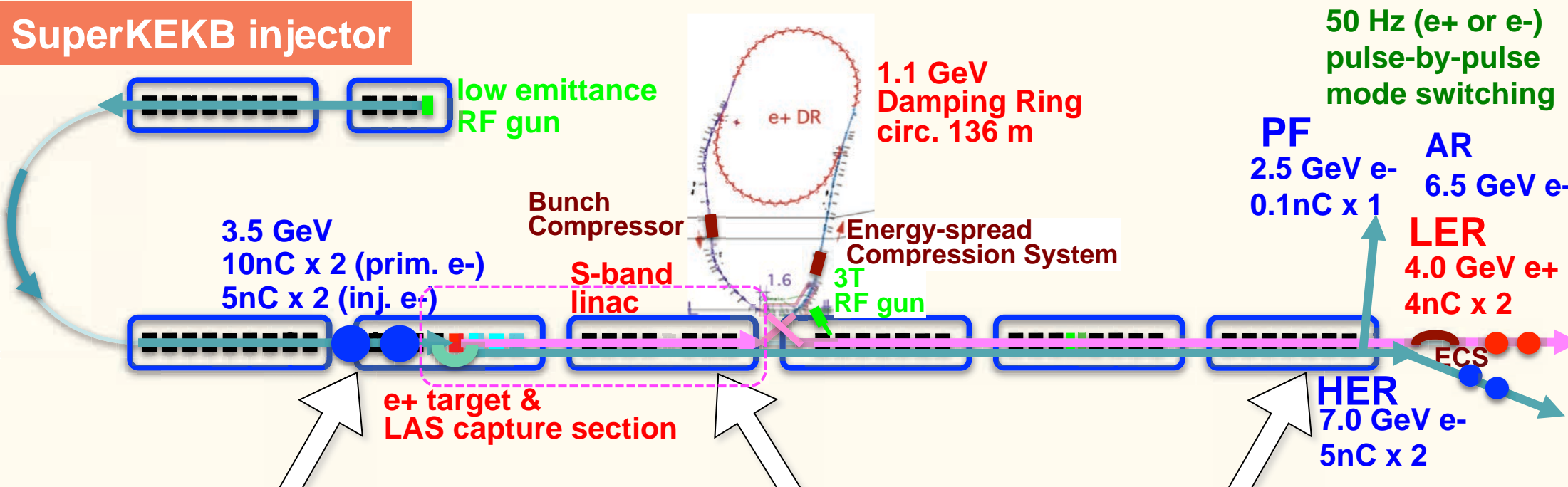

[1] Sector 1,2
 Electricity and cooling water addition for new positron generator
 ±920 kVA, ±900 L/min

[2] Sector 2,3
 Electricity addition for new damping ring
 ±310 kVA

[3] Sector 5
 Electricity and cooling water addition for energy compression, beam diag., injection beamlines
 ±300 kVA, ±460L/min



Alignment

- ◆ **High-precision alignment was not necessary in PF and KEKB injections, and it was much damaged by earthquake in 2011.**
- ◆ **Instead of flexible-structure girder before earthquake, rigid-structure was adopted with jack-volts and fixed supports.**
- ◆ **Reflector pedestals are developed and mounted onto quad magnets and accelerating cavities for laser-tracker measurement.**
- ◆ **Iterative measurement and adjustment with 500-m straight laser and position sensors should enable 0.3-mm global alignment.**
- ◆ **Laser tracker should enable 0.1-mm measurement within 10-m girder unit.**
- ◆ **Displacement gauges, hydrostatic leveling, inclinometer are also employed.**
- ◆ **Remote measurement system and girder mover system will be necessary for longer term, and are under development.**



Alignment progress in 2014

- ◆ For the first time at 3-5 sectors
- ◆ Horizontal axis: sensor number from sector C, 1-4, to sector 5 (~80 m/sector)
- ◆ Vertical axis: voltage (~displacement at 0.25~0.5mm/mV)
- ◆ Some girders were not yet upgraded
- ◆ Moved up to 3 mm not to break vacuum

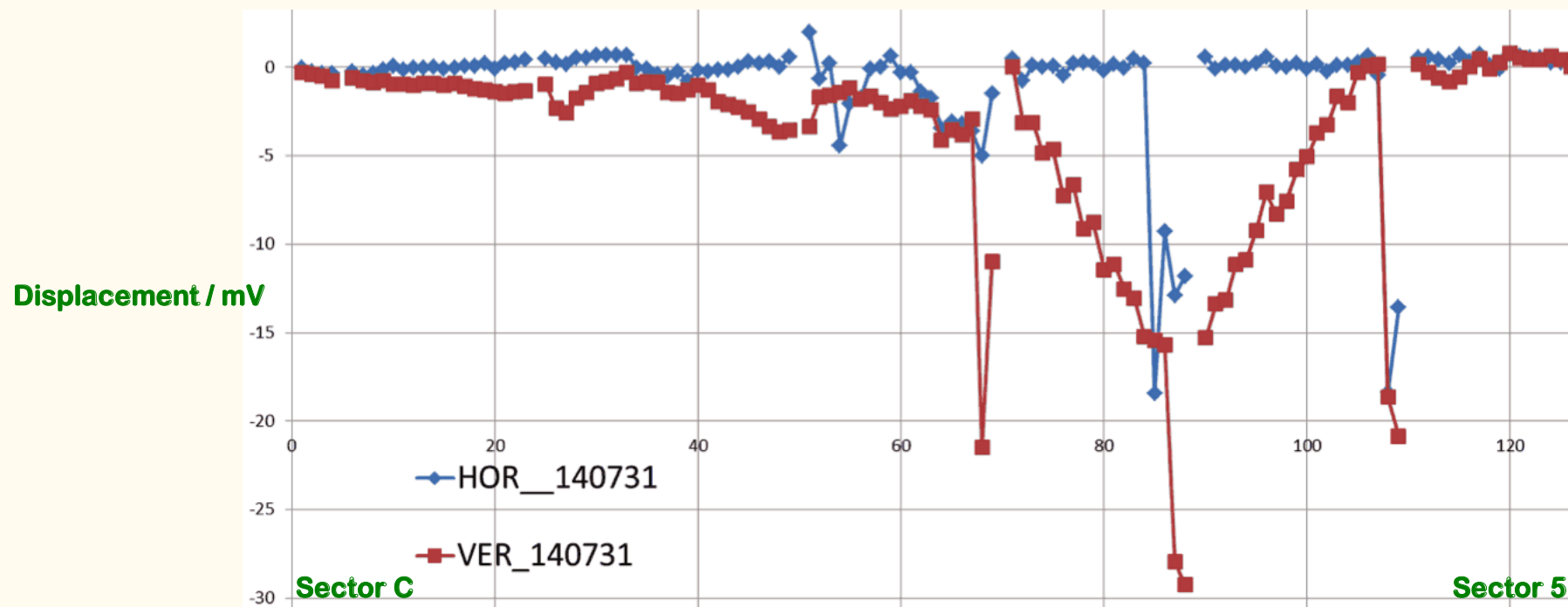

Alignment progress in 2014

Higo et al.

- ◆ For the first time after earthquake at downstream sectors
- ◆ Several measurements during summer
- ◆ Measurement reproducibility was confirmed up to ≈ 0.2 mm
- ◆ While there existed several conflicting measurements, consistent scheme has been established
- ◆ Movement of tunnel by several 10's of micrometer was observed (\rightarrow mover)
- ◆ Further work necessary in 2015, for alignment and girder replacement

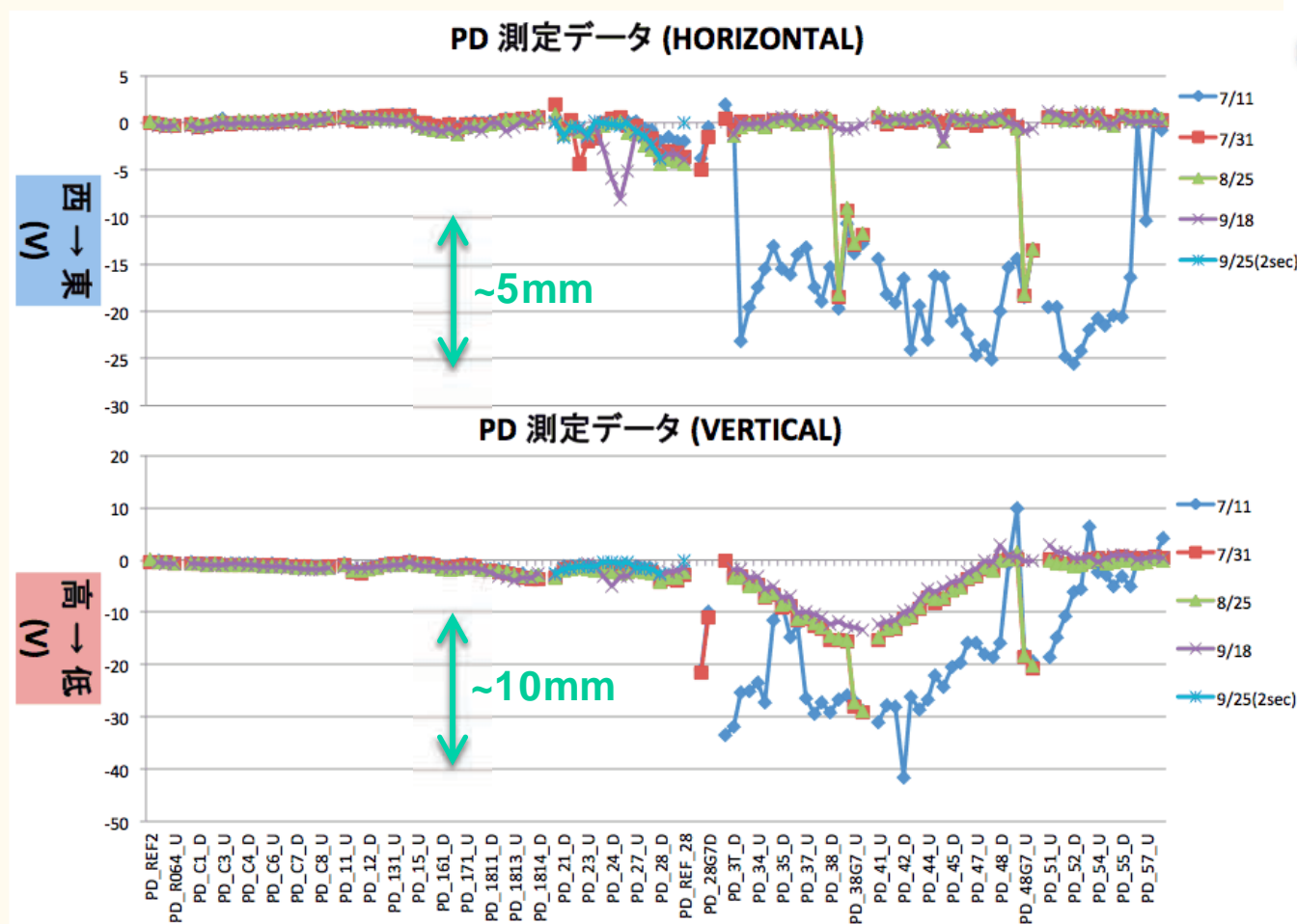

Positron Generation

◆ 4-times more positron is required at SuperKEKB than KEKB

- ❖ Safety measure was taken after cable fire during the test of Flux Concentrator (FC)
- ❖ New components in 100-m capture section were tested in steps
- ❖ High voltage tests in tunnel in April
- ❖ Beam tests with electron in May



Positron generation for SuperKEKB

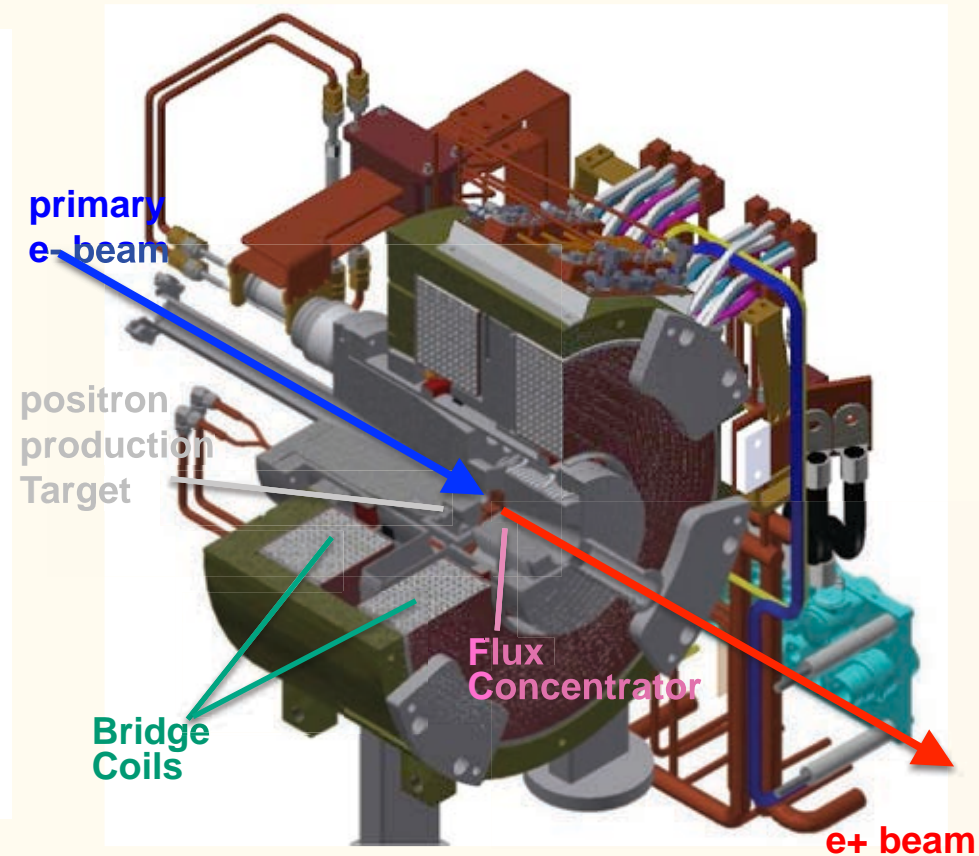
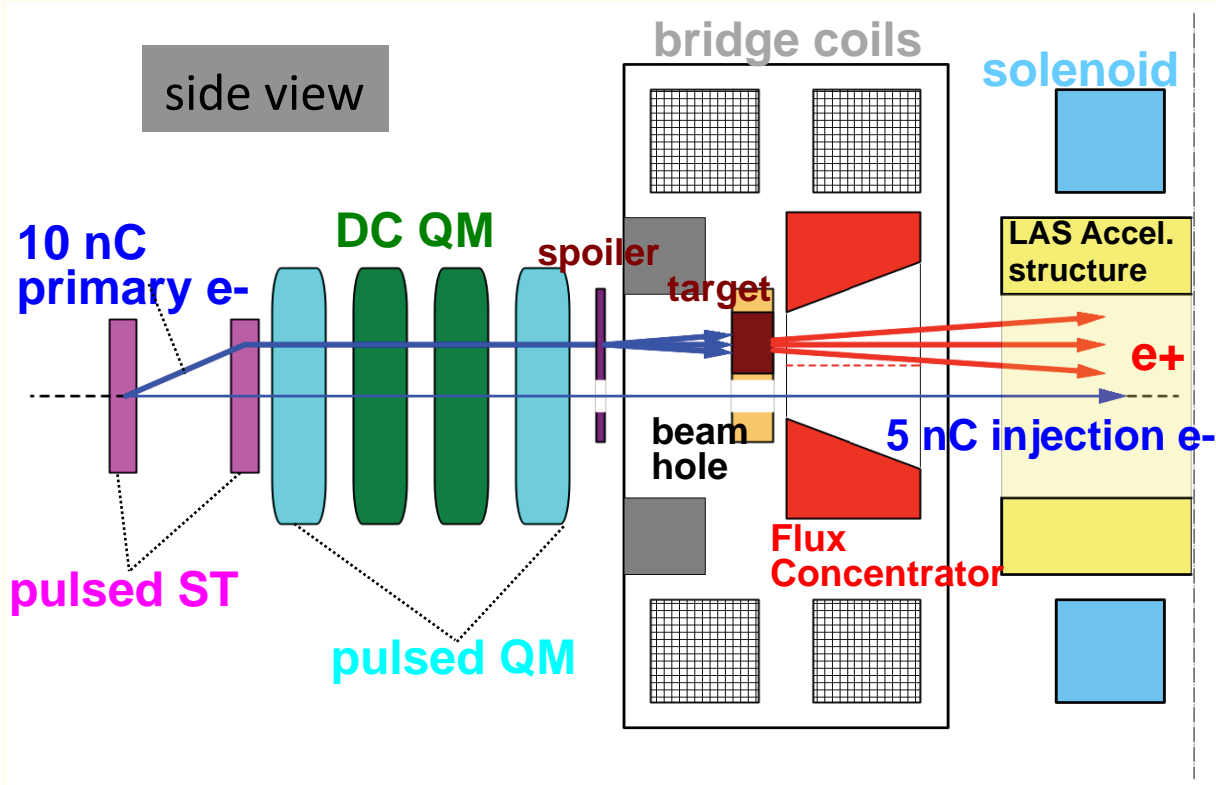

- New positron capture section after target with Flux concentrator (FC) and large-aperture S-band structure (LAS)
- Satellite bunch (beam loss) elimination with velocity bunching
- Pinhole (2mm) for electrons beside target (3.5mm)
- Beam spoiler for target protection

陽電子捕獲部@Linacトンネル

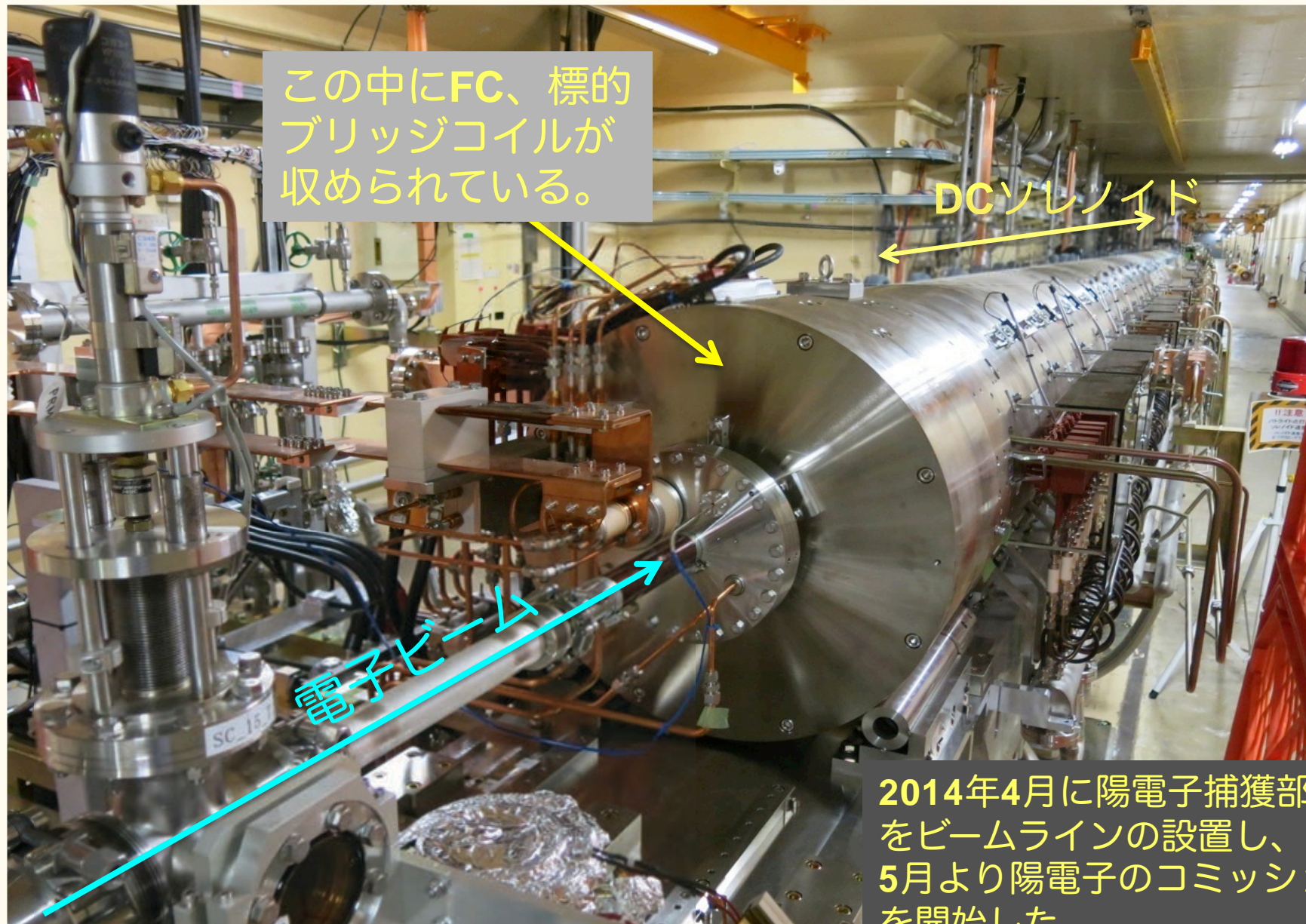

Positron from New Positron Capture Section

- ◆ Generated positron ≈ 0.1 nC was transferred to the entrance of damping ring
- ◆ With higher magnetic and electric field, 4-nC positron will be generated
- ◆ Target shield (40cm x 6m long) will be finalized
- ◆ Alignment will be improved 3mm \rightarrow 0.1mm

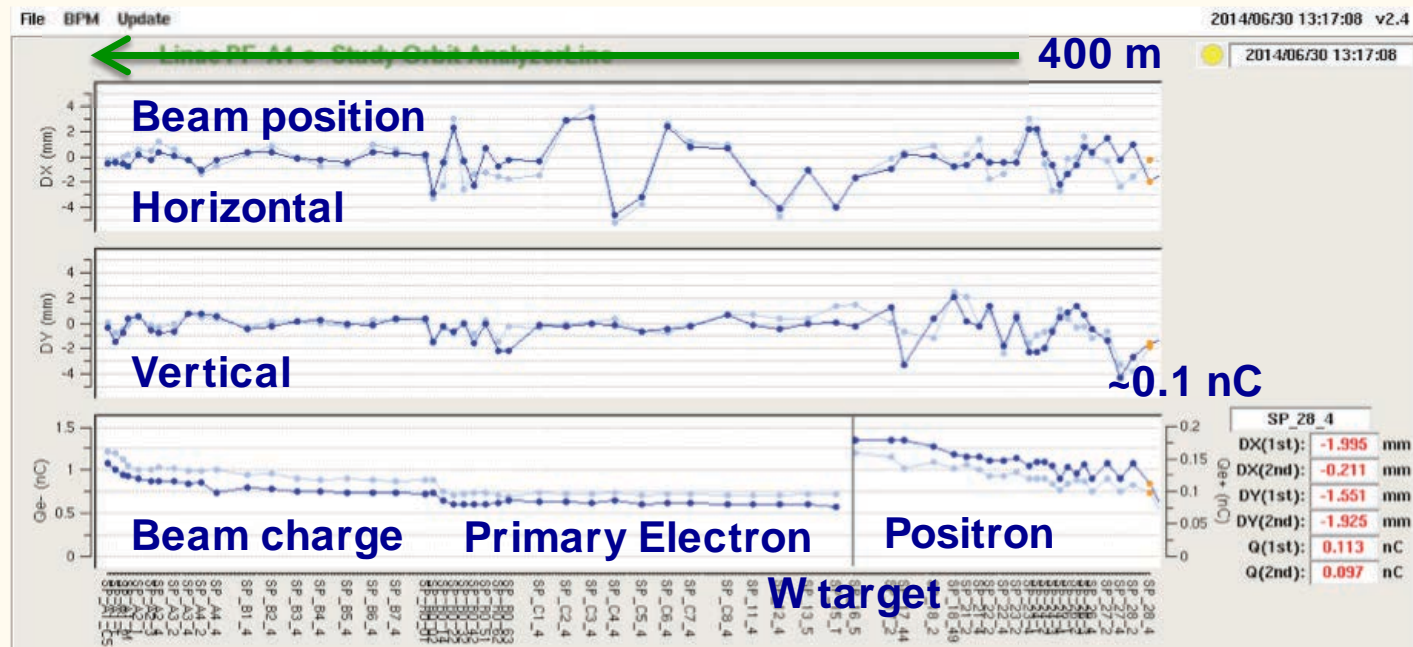
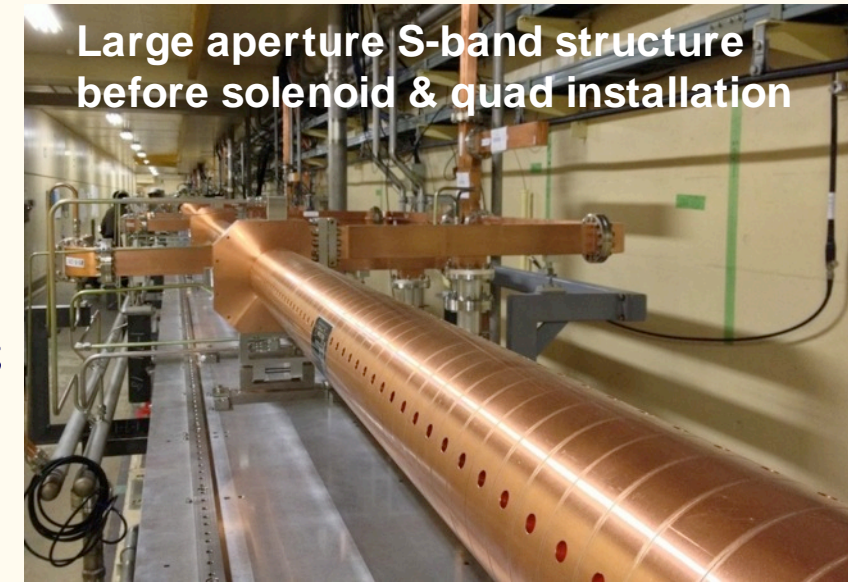



(1) FC current

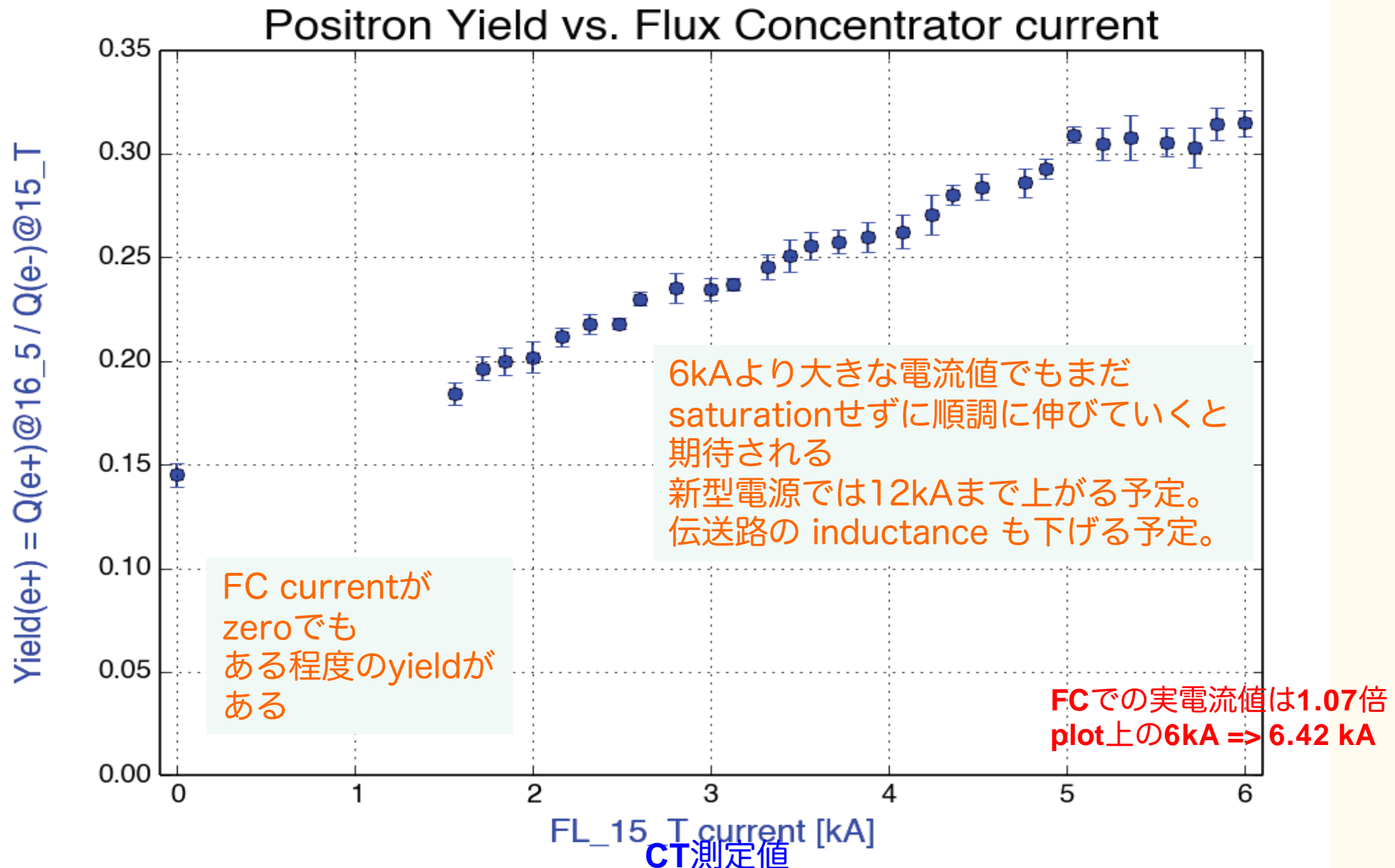



Positron Generation

- 1) **Installation of positron generator for SuperKEKB in April 2014**
(Beamline construction since summer 2013)
(positron target, spoiler, Flux Concentrator, bridge coils, LAS structures [x6], DC solenoids [16+13], e⁺/e⁻ separator, quads [>90])
- 2) **Commissioning of positron beam, observation of the first positron after reconstruction for SuperKEKB, further improvements expected**

	Primary e ⁻ [nC]	Positron [nC]	Efficiency	Parameters
June 2014	0.6	0.12	20%	FC 6.4kA, Solenoids 370A, LAS capture field 10 MV/m
Specification (at SY2)	10.0	5.0	50%	FC 12kA, Solenoids 650A, LAS capture field 14 MV/m
DR injection (2017?)		4.0	40%	Energy spread acceptance 0.5%

- 3) **Oct.~Dec.2014 : Linac commissioning**
Jan.~Mar.2015 : Construction
Jul.~Sep.2015 : Construction

Apr.~Jun. : Linac commissioning
Oct (?) : LER injection

陽電子生成装置遮蔽体

1-5 陽電子ターゲット下流の加速器上空に鉄を主体としたシールドを設置する。

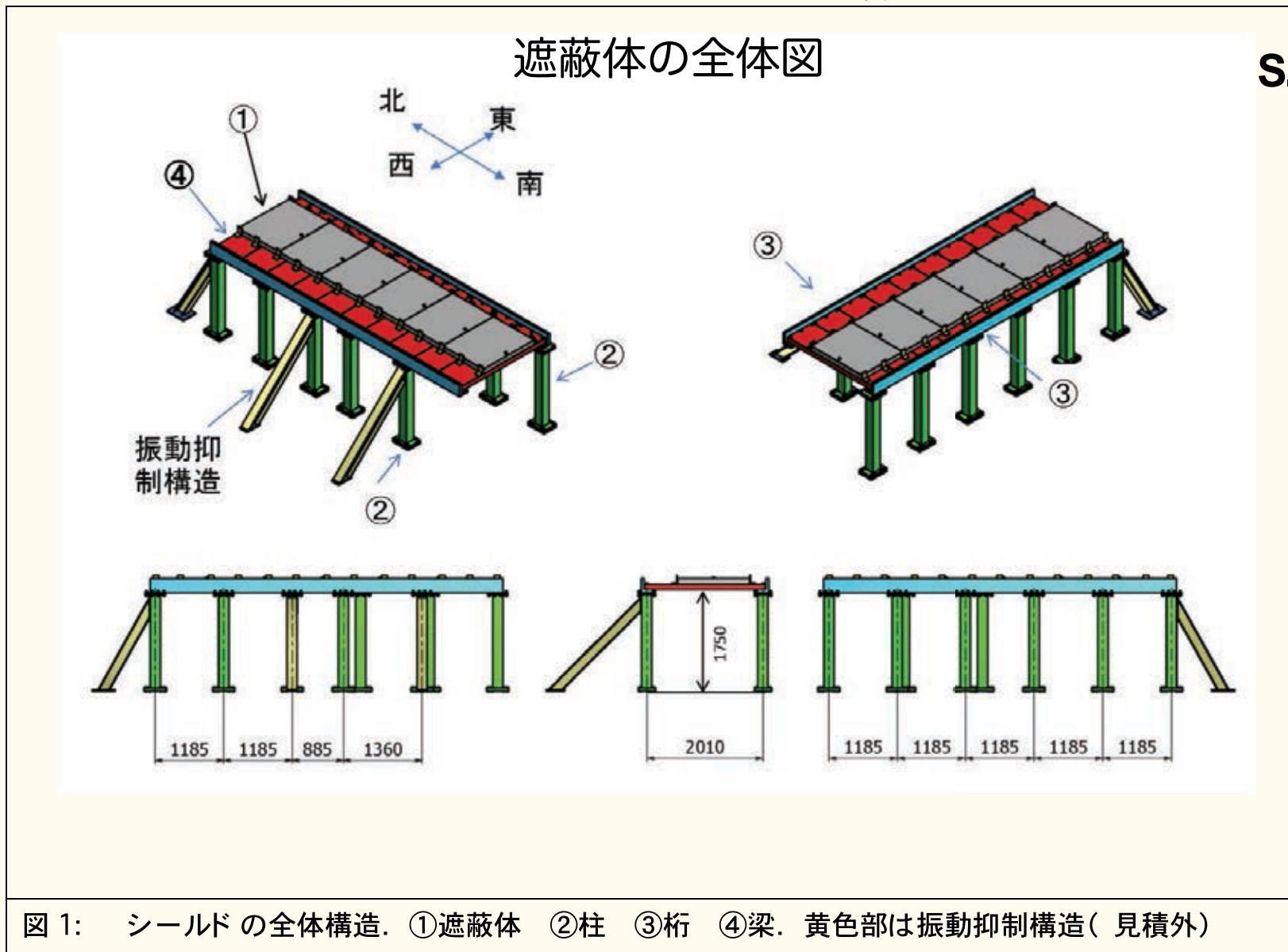

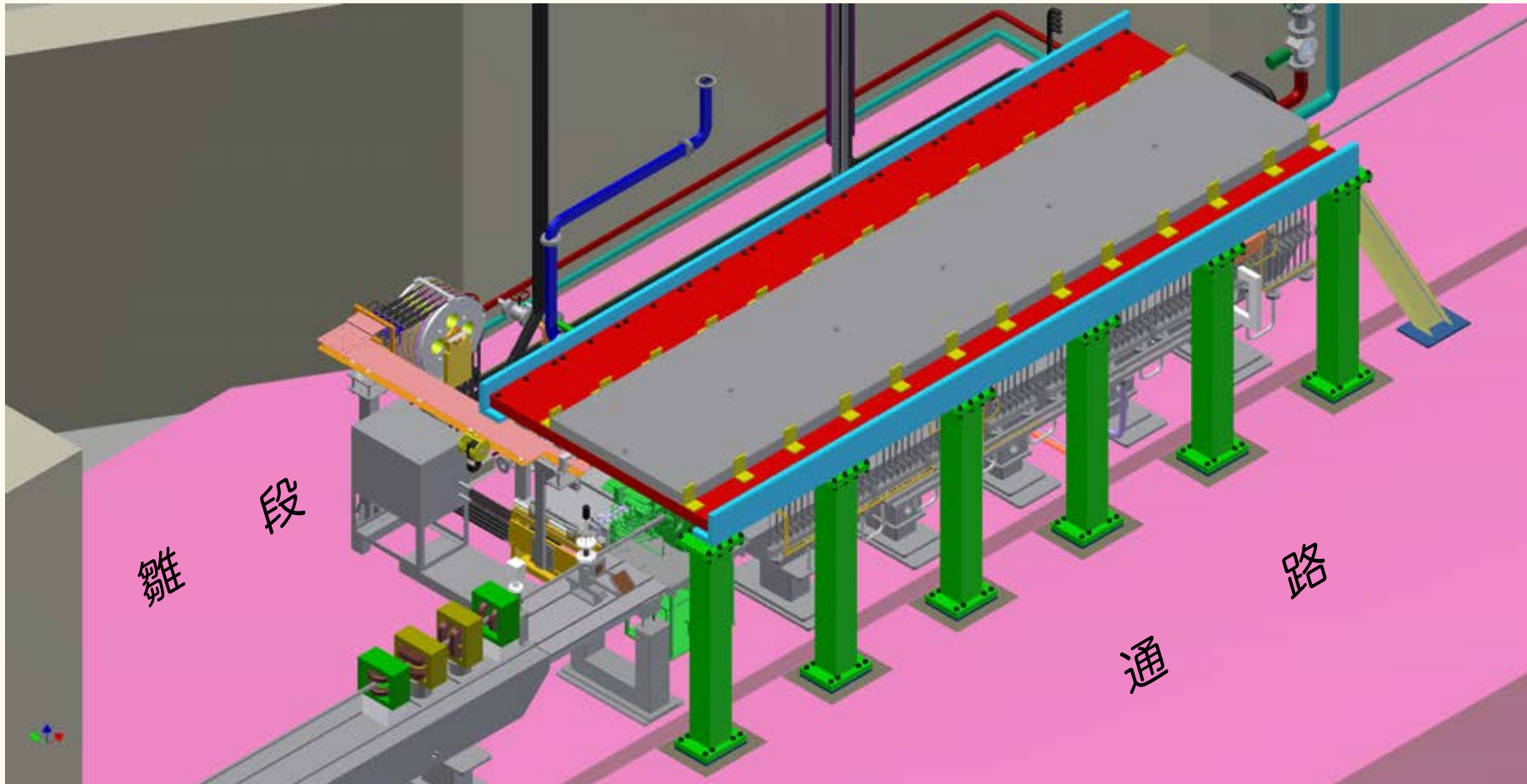

鳥瞰図：南東方向から見た図。 トンネル1-5 陽電子ターゲットの60cm上流から6mの範囲に設置。今年度は、遮蔽鉄の厚みは200mm（図中の赤+灰色部）。200mm角柱 6本が現場通路上ビームラインよりに設置される。鉛カーテンを設置すると、通路の幅が現場では1400mm。3月末までに建設。



Photo cathode RF gun development

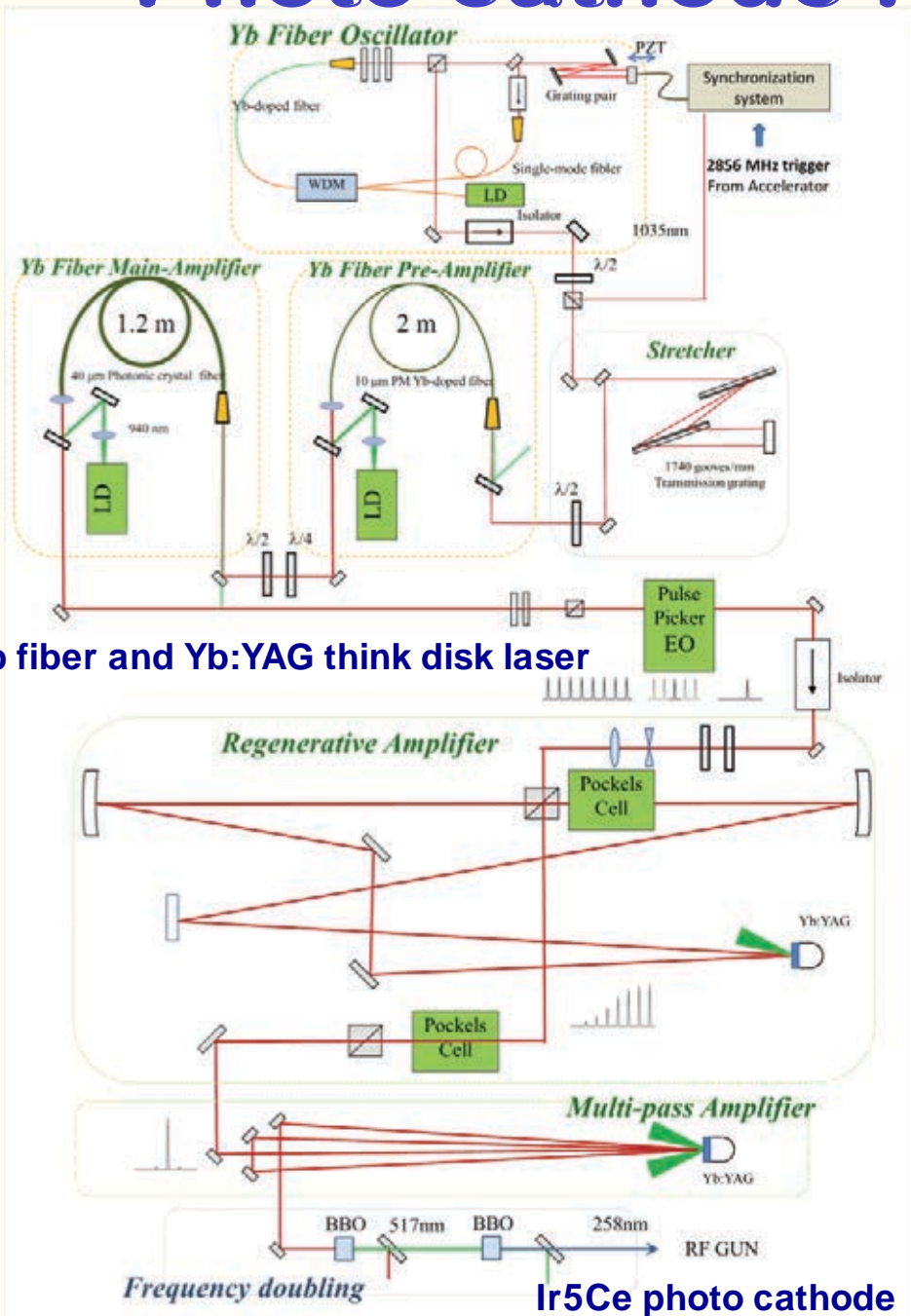

Yb fiber and Yb:YAG think disk laser

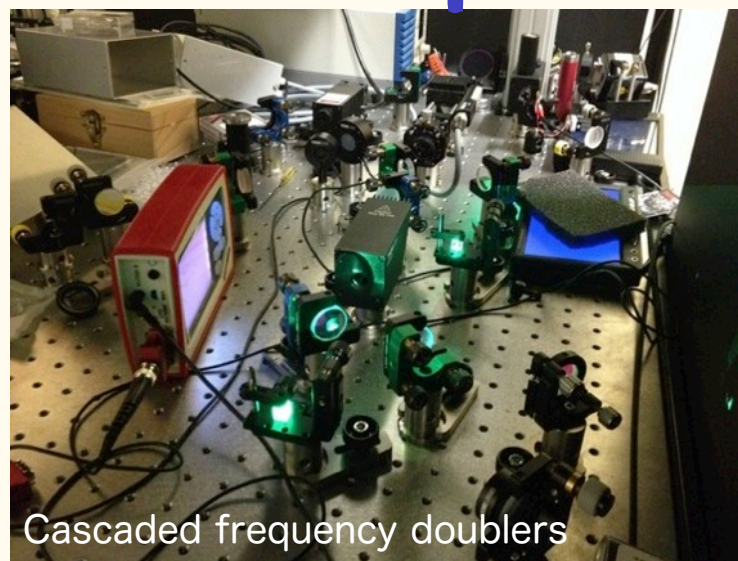

Cascaded frequency doublers

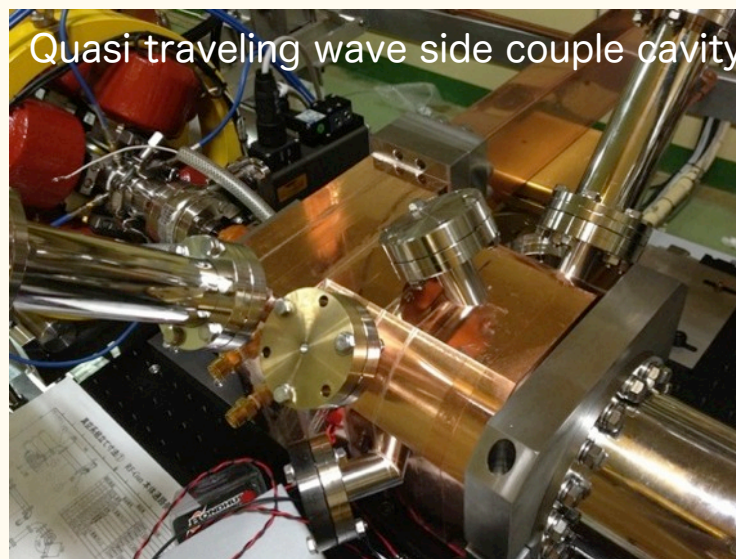

Quasi traveling wave side couple cavity



Ir₅Ce Cathode

- ◆ **5.6 nC / bunch was confirmed**
- ◆ **Next step: 50-Hz beam generation & Radiation control**

RF-Gun development strategy for SuperKEKB

- ◆ **Cavity : Strong electric field focusing structure**
 - ❖ Disk And Washer (DAW) ⇒ 3-2, A-1(test)
 - ❖ Quasi Traveling Wave Side Couple ⇒ A-1
 - ⇒ Reduce beam divergence and projected emittance dilution
- ◆ **Cathode : Long term stable cathode**
 - ❖ Middle QE (QE=10⁻⁴~10⁻³ @266nm)
 - ❖ Solid material (no thin film) ⇒ Metal composite cathode
 - ⇒ Started from LaB₆ (short life time)
 - ⇒ Ir₅Ce has very long life time and QE>10⁻⁴ @266nm
- ◆ **Laser : Stable laser with temporal manipulation**
 - ❖ LD pumped laser medium ⇒ Nd / Yb doped
 - ❖ Temporal manipulation ⇒ Yb doped
 - ⇒ Minimum energy spread

Design of a quasi traveling wave side couple RF gun

M. Yoshida et al

Normal side couple structure

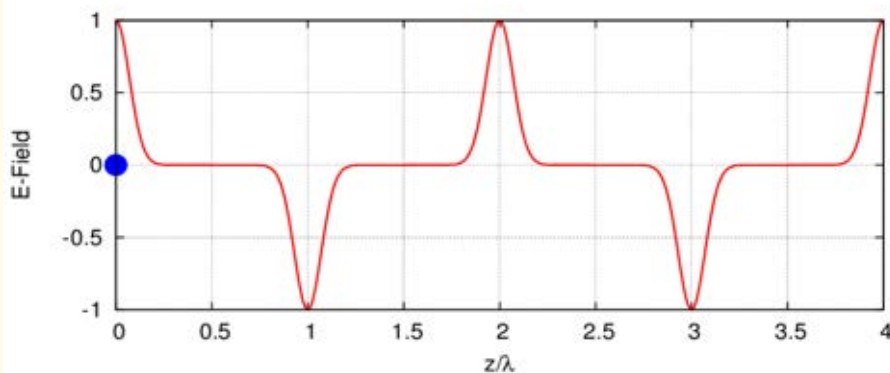
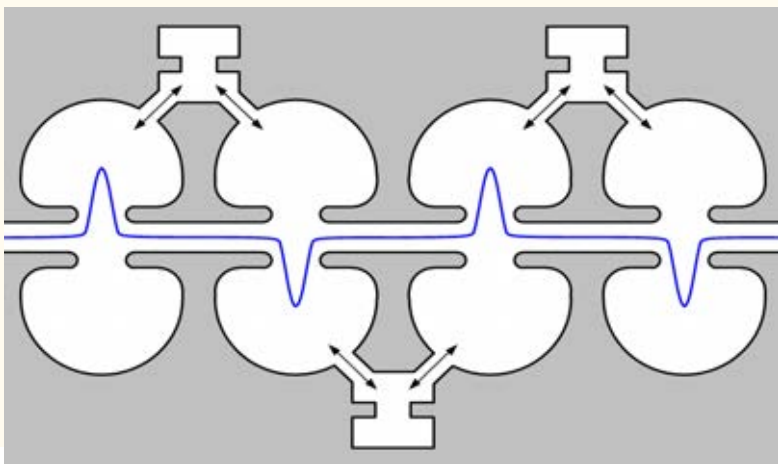

Quasi traveling wave sidecouple structure

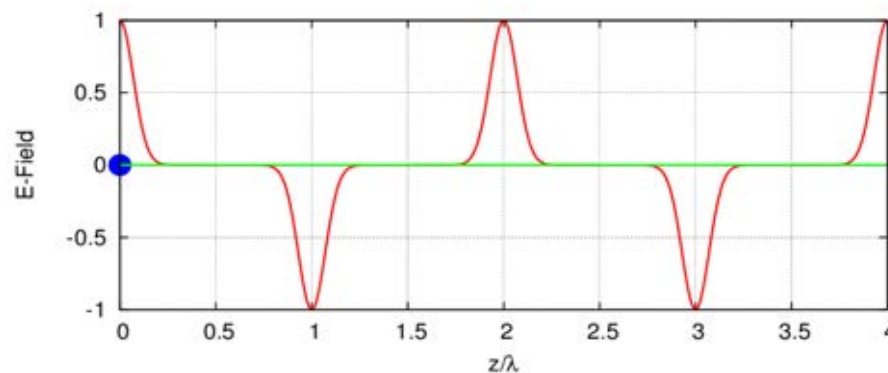
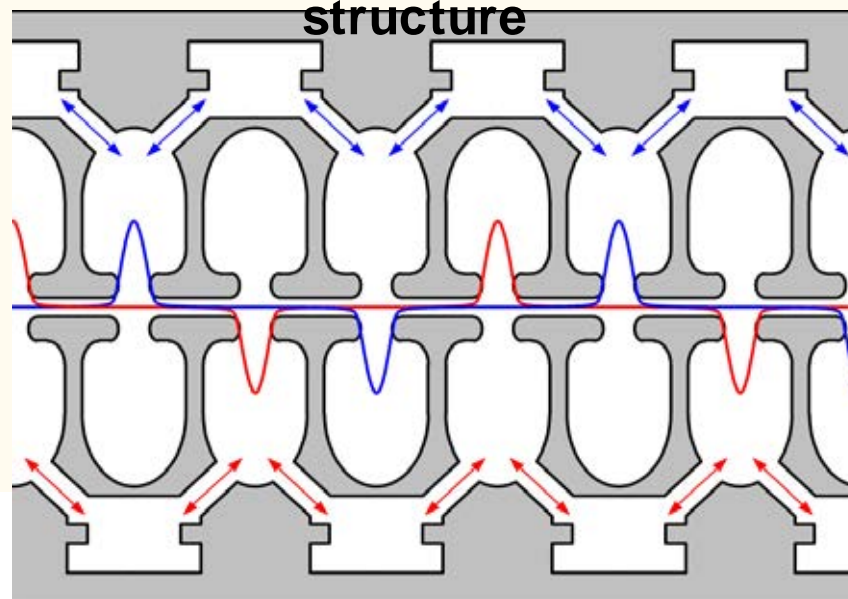

Quasi traveling wave side couple has stronger focusing field



Beam tracking simulation result

M. Yoshida

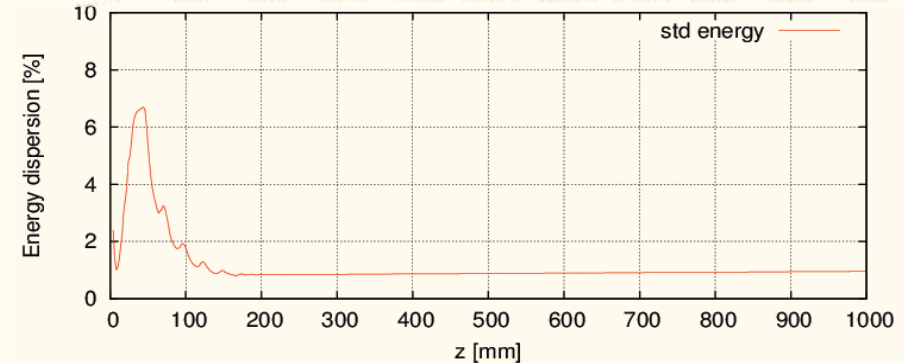
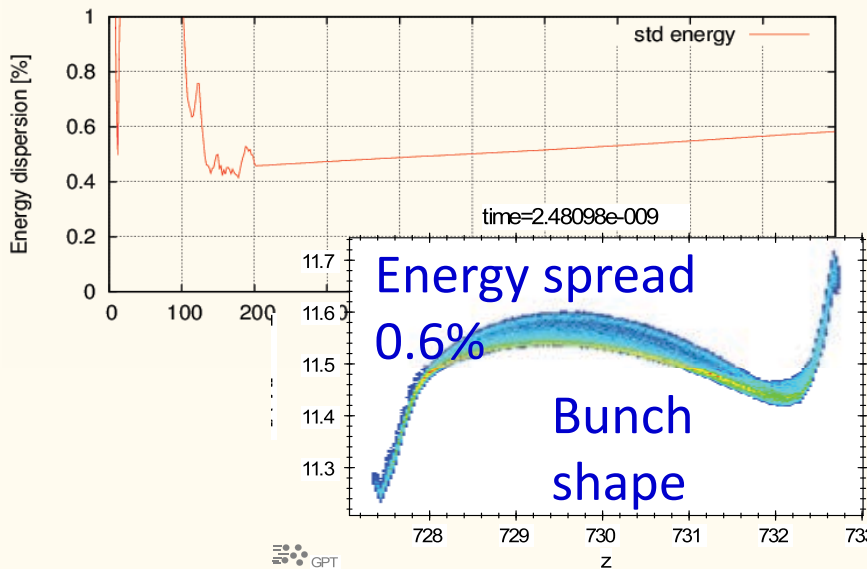
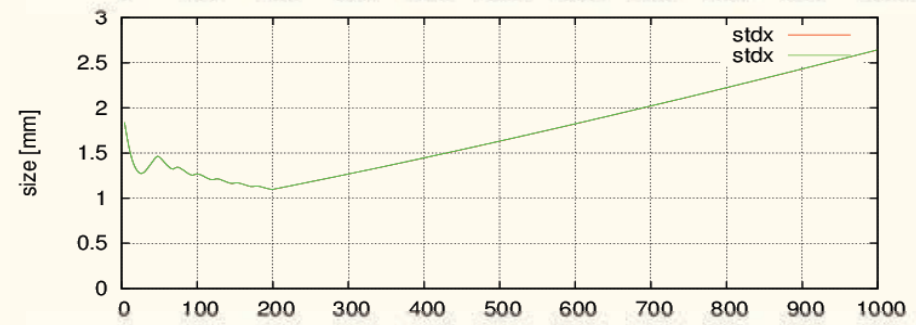
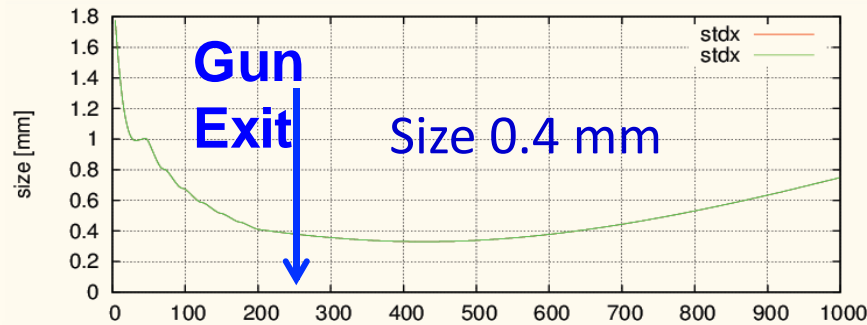
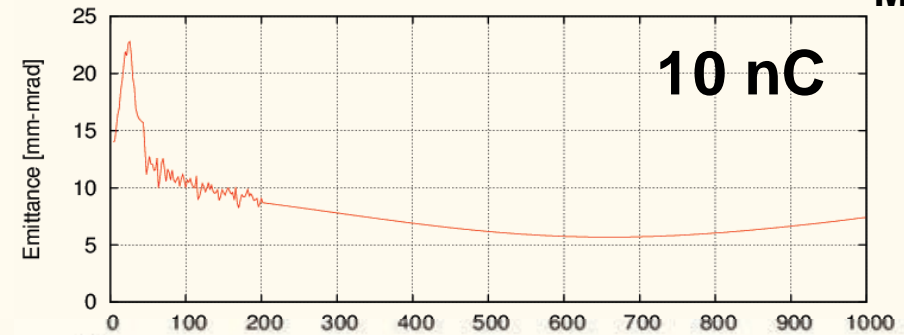
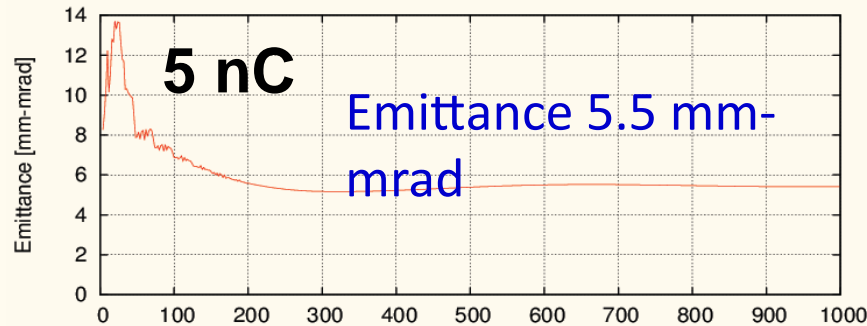

RF-Gun comparison

M. Yoshida

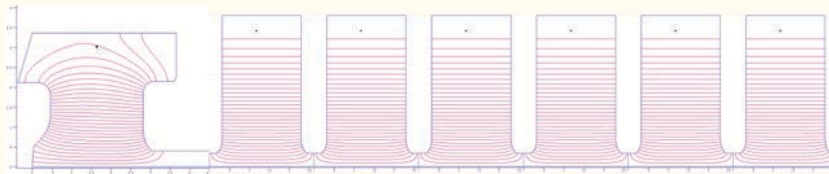

Quasi traveling wave side couple RF gun
(100 MV/m, 6mm-mrad, 13.5 MeV)

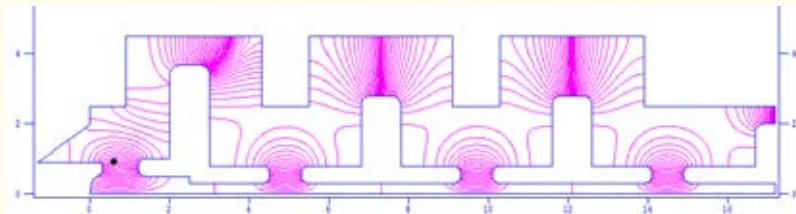

DAW-type RF gun
(90 MV/m, 5 mm-mrad, 3.2 MeV)

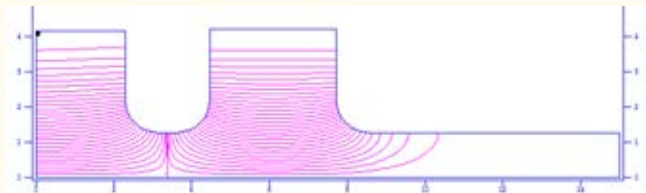

BNL-type RF gun
(120 MV/m, 11.0 mm-mrad, 5.5 MeV)

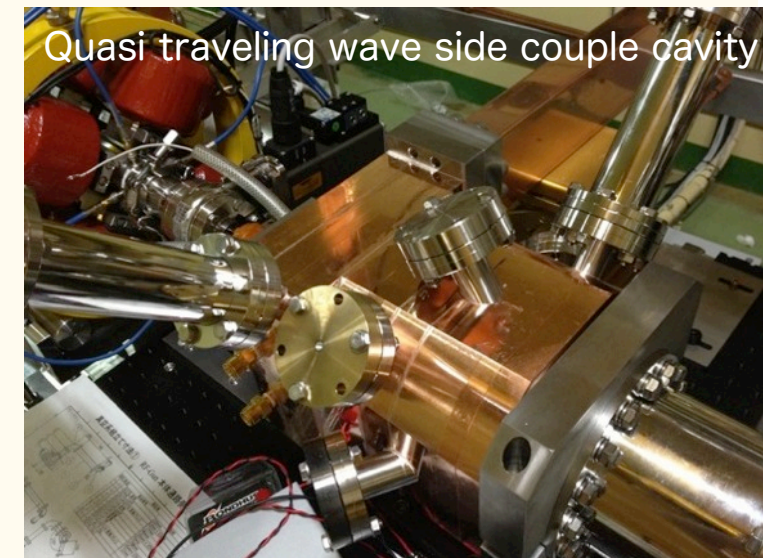
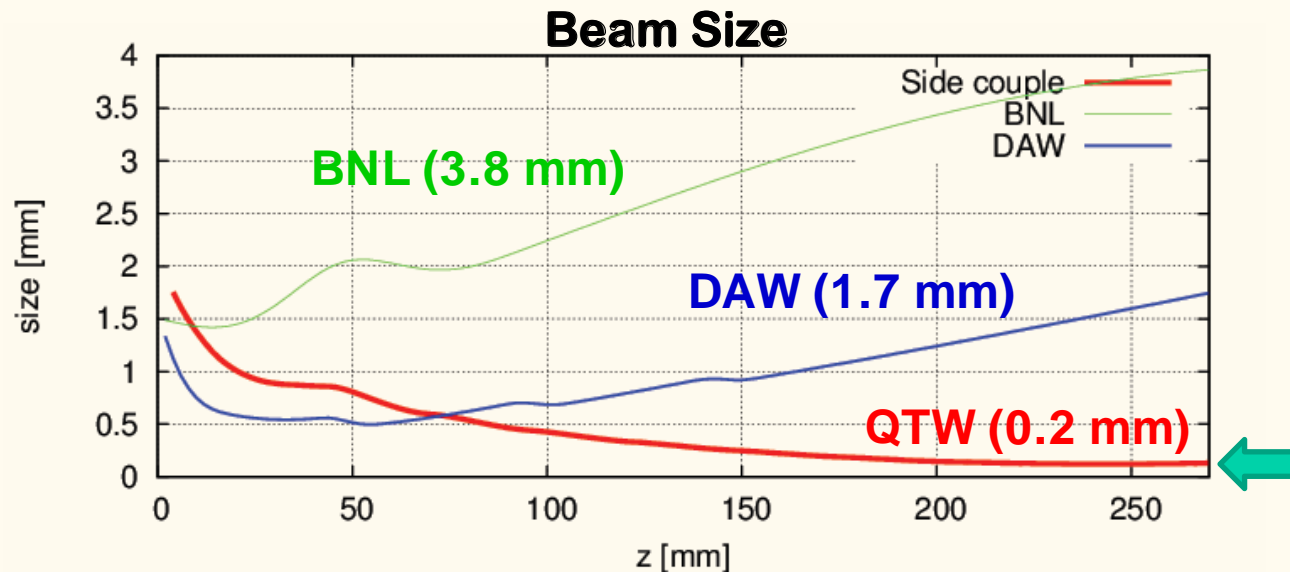

Ir₅Ce Cathode

Quantum efficiency improvement
by Laser cleaning

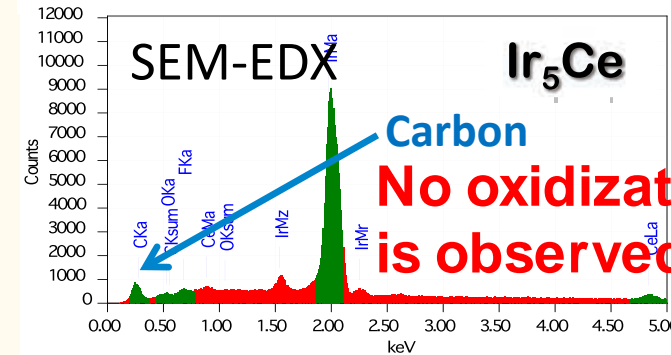
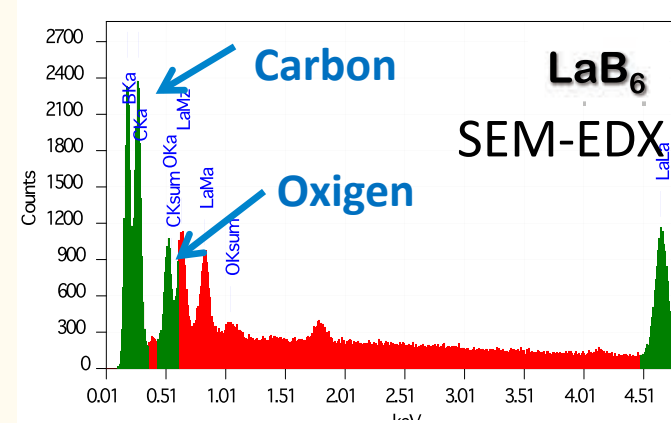
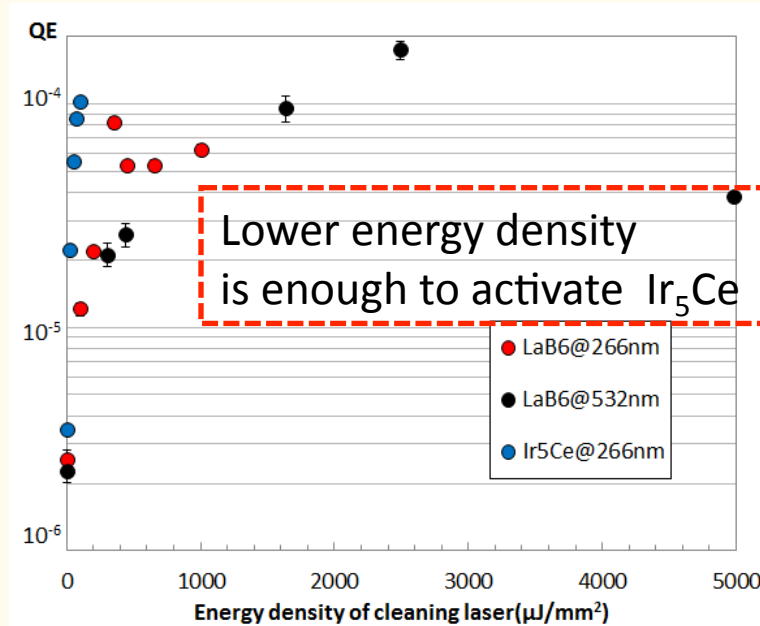

M. Yoshida

QE Enhancement of IrCe cathode

QE lifetime

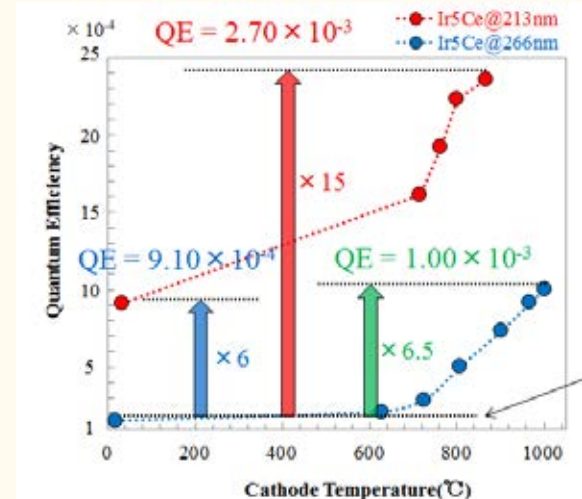
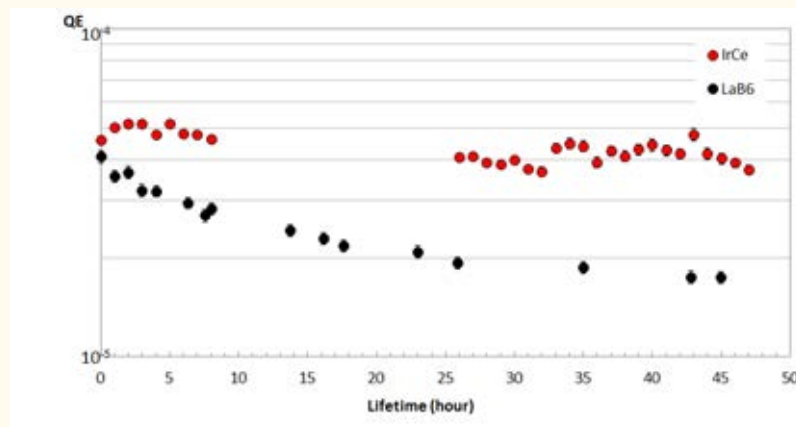



Energy spread reduction using temporal manipulation

M. Yoshida

Energy spread of 0.1% is required for SuperKEKB synchrotron injection.

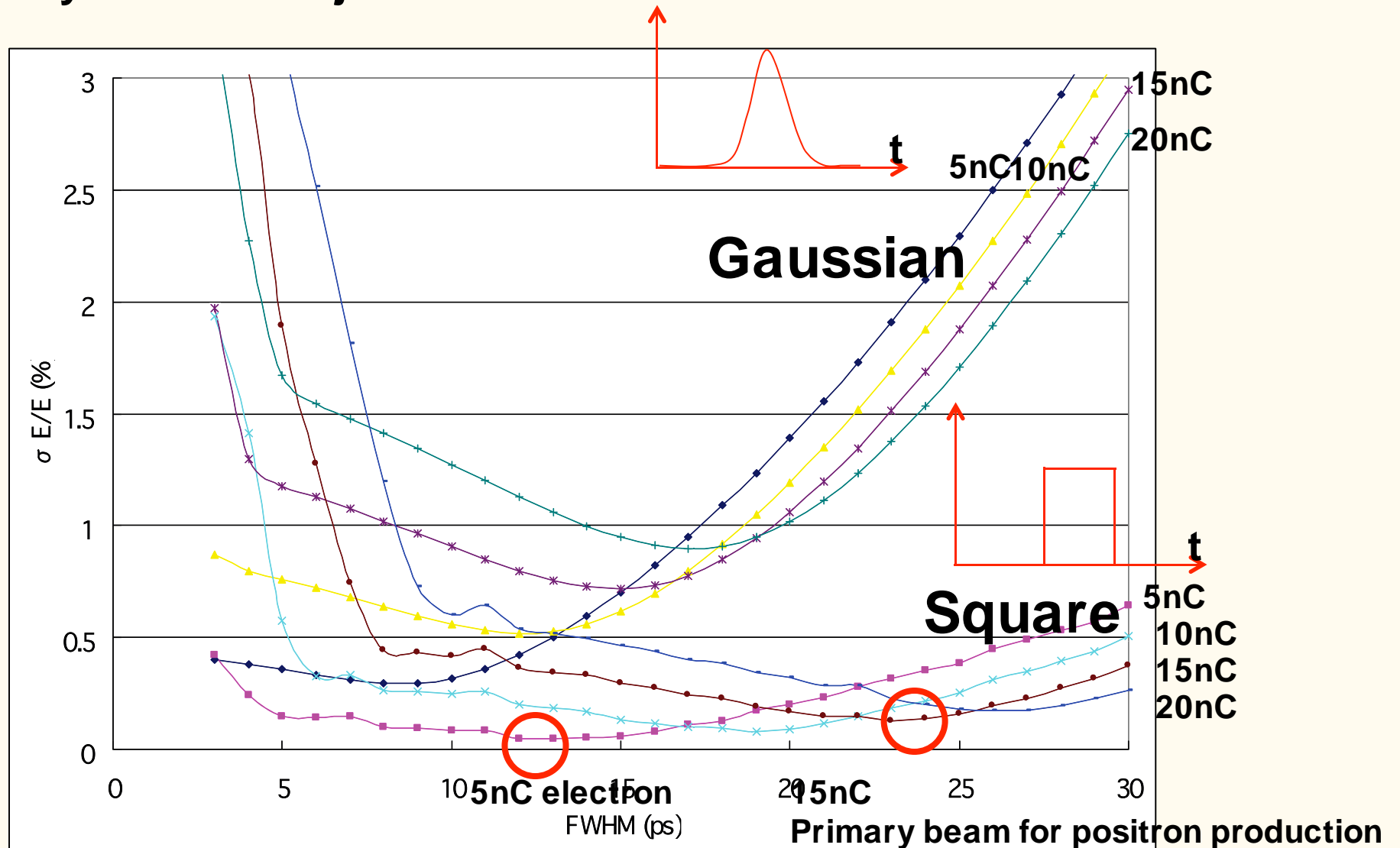

Properties of laser medium

Nd-doped

- 4-state laser is easy to operate.
- High power pump LD is available.
- Large crystal is available
- × Pulse width is determined by SESAM.
(Gaussian)

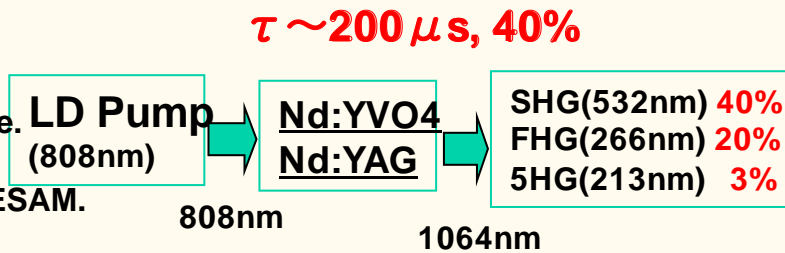

Nd laser system for 3-2 RF-Gun

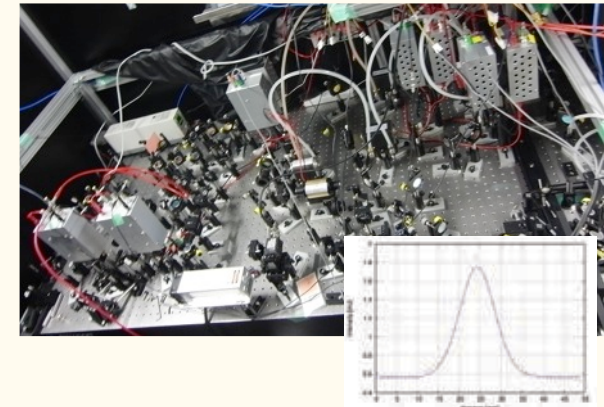

Yb-doped

- Wide bandwidth => pulse shaping
- Long fluorescent time => High power
- Fiber laser oscillator => Stable
- Small state difference
- × ASE
- × Absorption

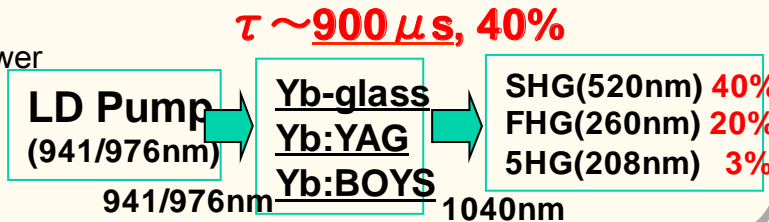

➔ Best for Linac RF-Gun

Ti-doped

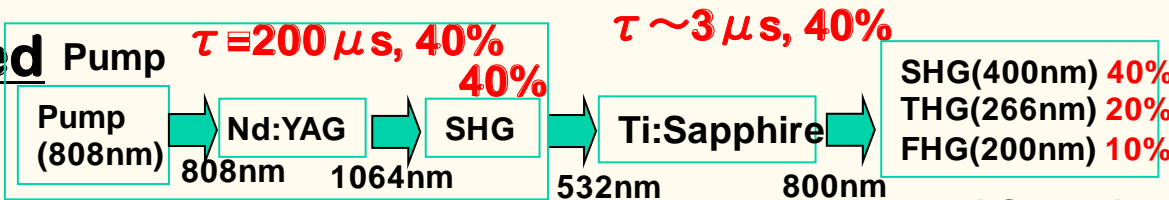

Ti:Sapphire laser system.

- Very wide bandwidth
 - High breakdown threshold
 - × Low cross section
 - × Short fluorescent time => Q-switched laser is required for pumping
- } TW laser is based on Ti-Sapphire

	Nd:YAG	Yb:YAG	Ti:Sapphire
Fluorescence	Material	Nd:YAG	Yb:YAG
	Wavelength	1064nm	1030nm
	Fluorescent time	230 μs	960 μs
	Spectral width	0.67nm	9.5nm
Absorption	Fourier minimum	2.48ps	165fs
	Pulse width	2.48ps	165fs
	Wavelength	807.5nm	941nm
	Quantum efficiency	76%	91%

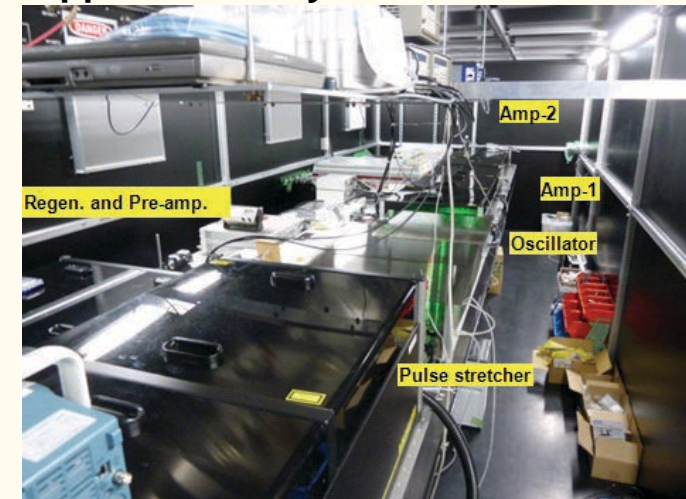

A-1 RF gun results

5.6 nC bunch charge was observed.

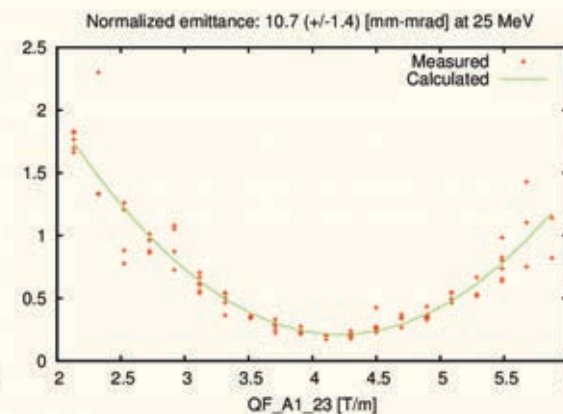
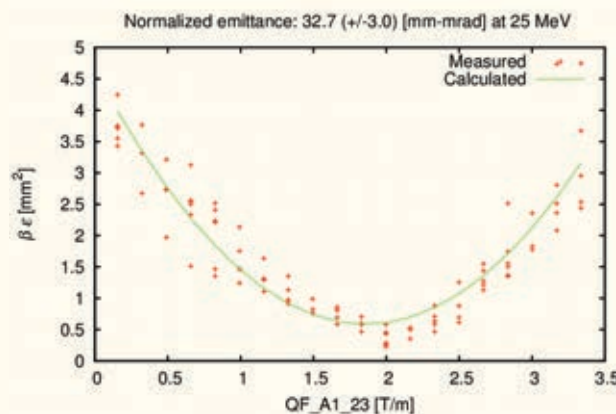
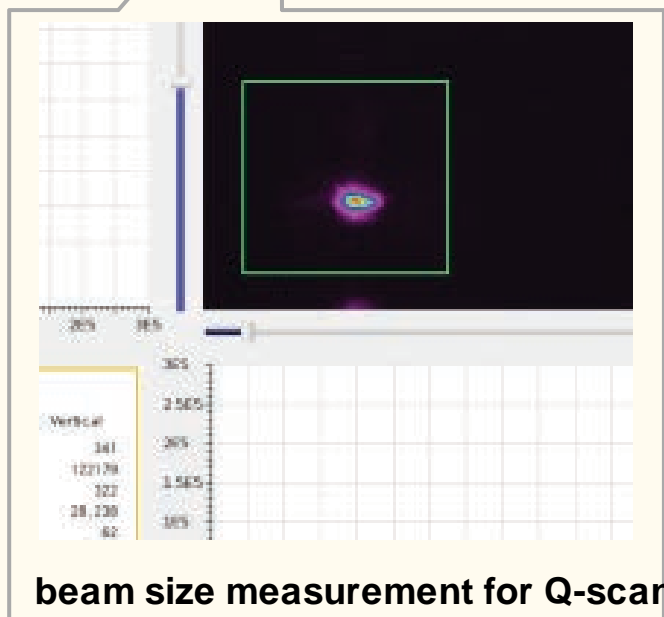
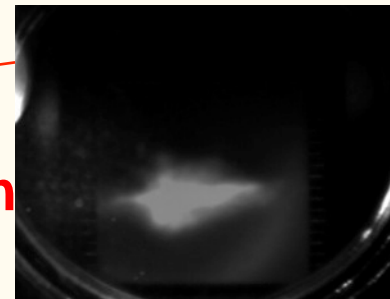
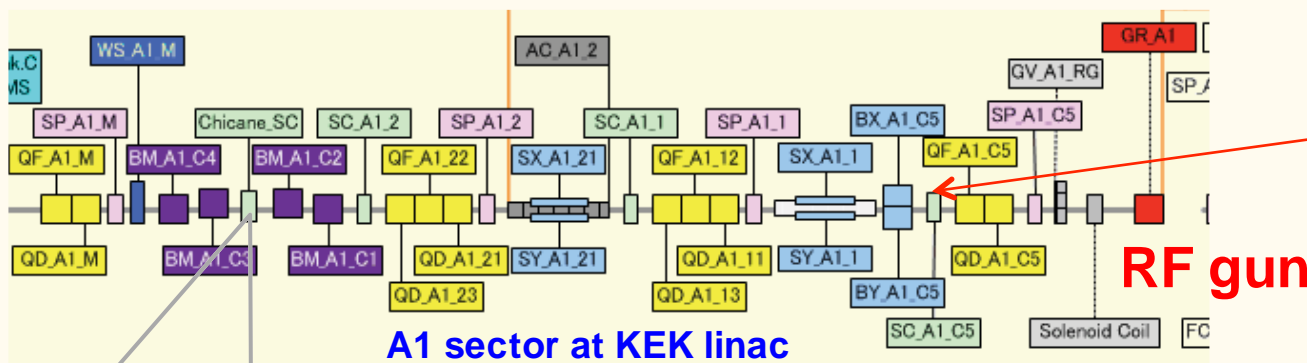

Q-scan emittance measurement

x	y
32.7 ± 3.1 mm-mrad	10.7 ± 1.4 mm-mrad

Photo cathode RF gun development

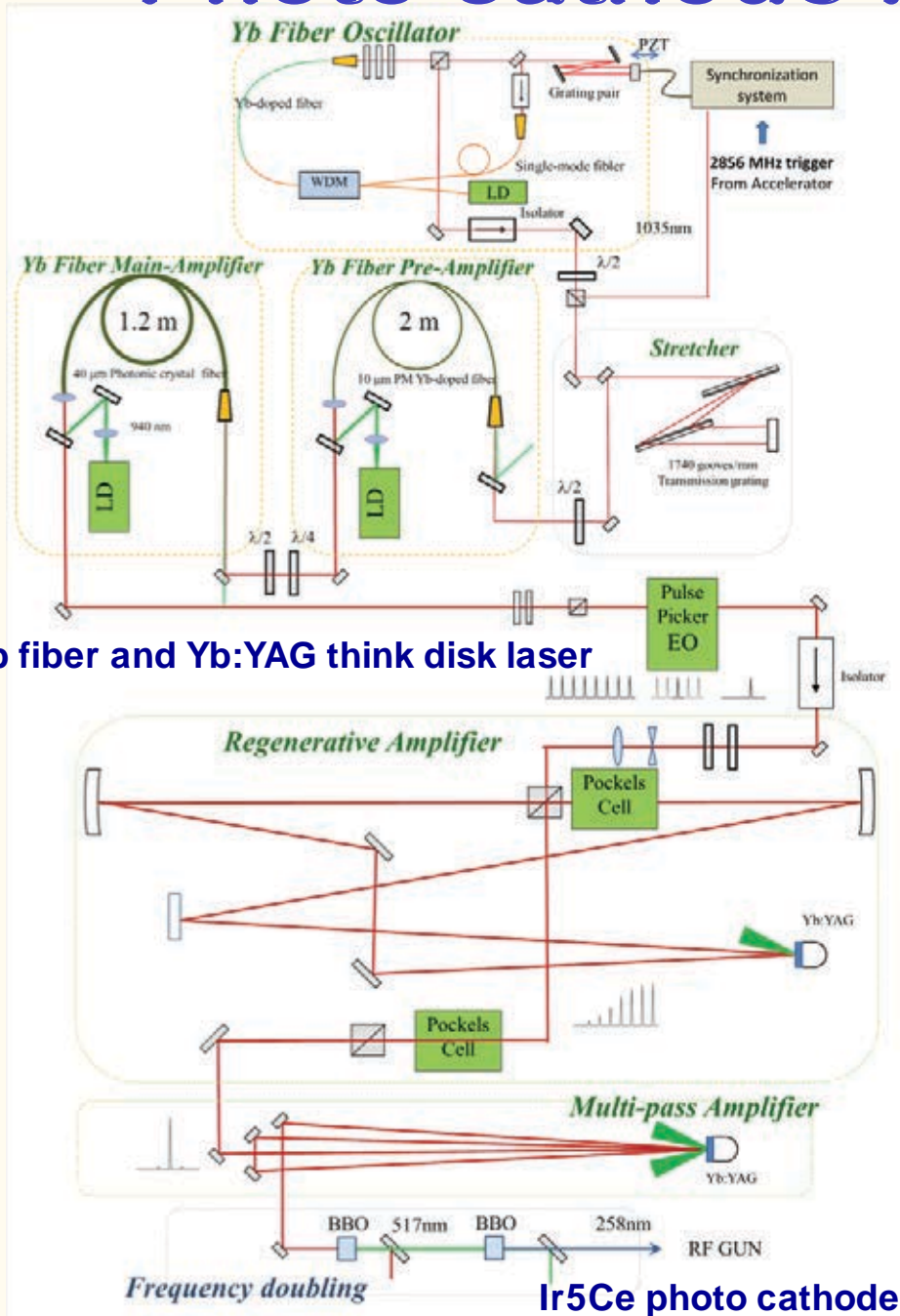

Yb fiber and Yb:YAG thick disk laser

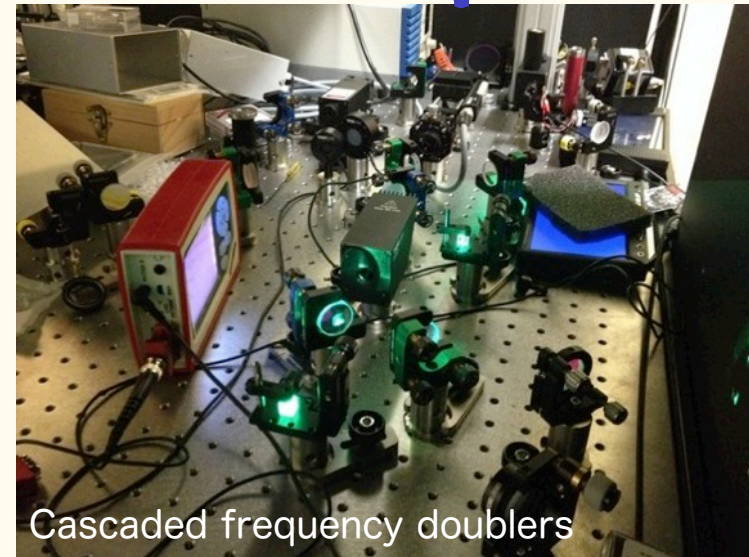

Quasi traveling

Part of multi-pass Amplifier

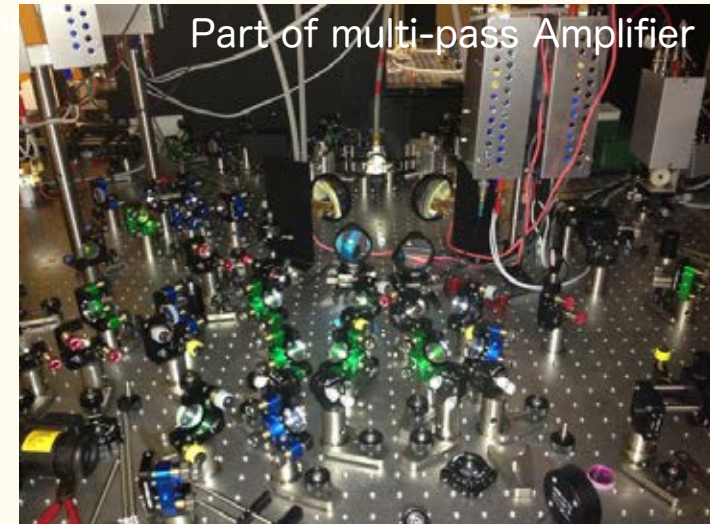

- ◆ 5.6 nC / bunch was confirmed
- ◆ Next step: 50-Hz beam generation & Radiation control

GU_A1 Laser Configuration as of Nov.2014

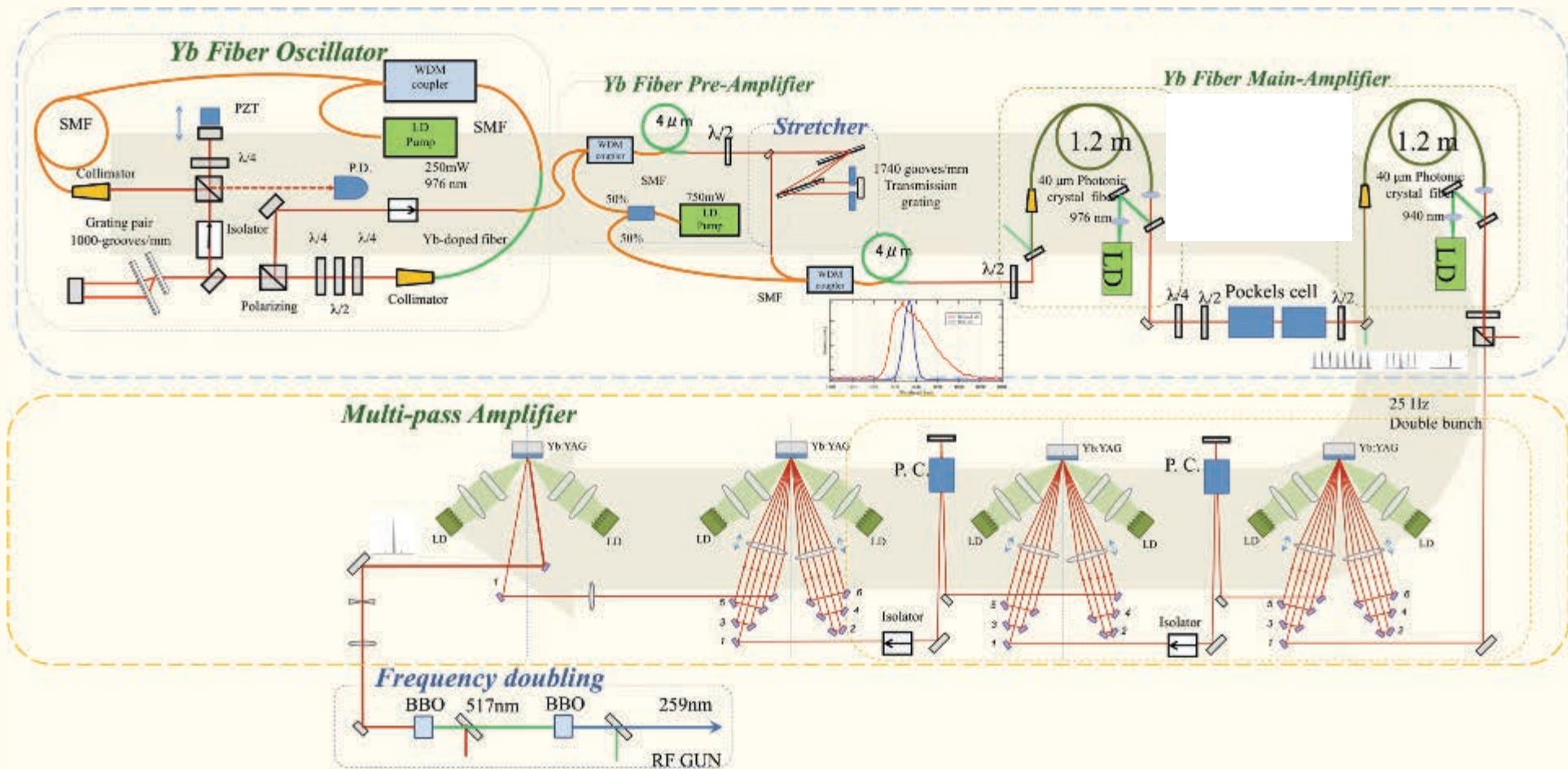
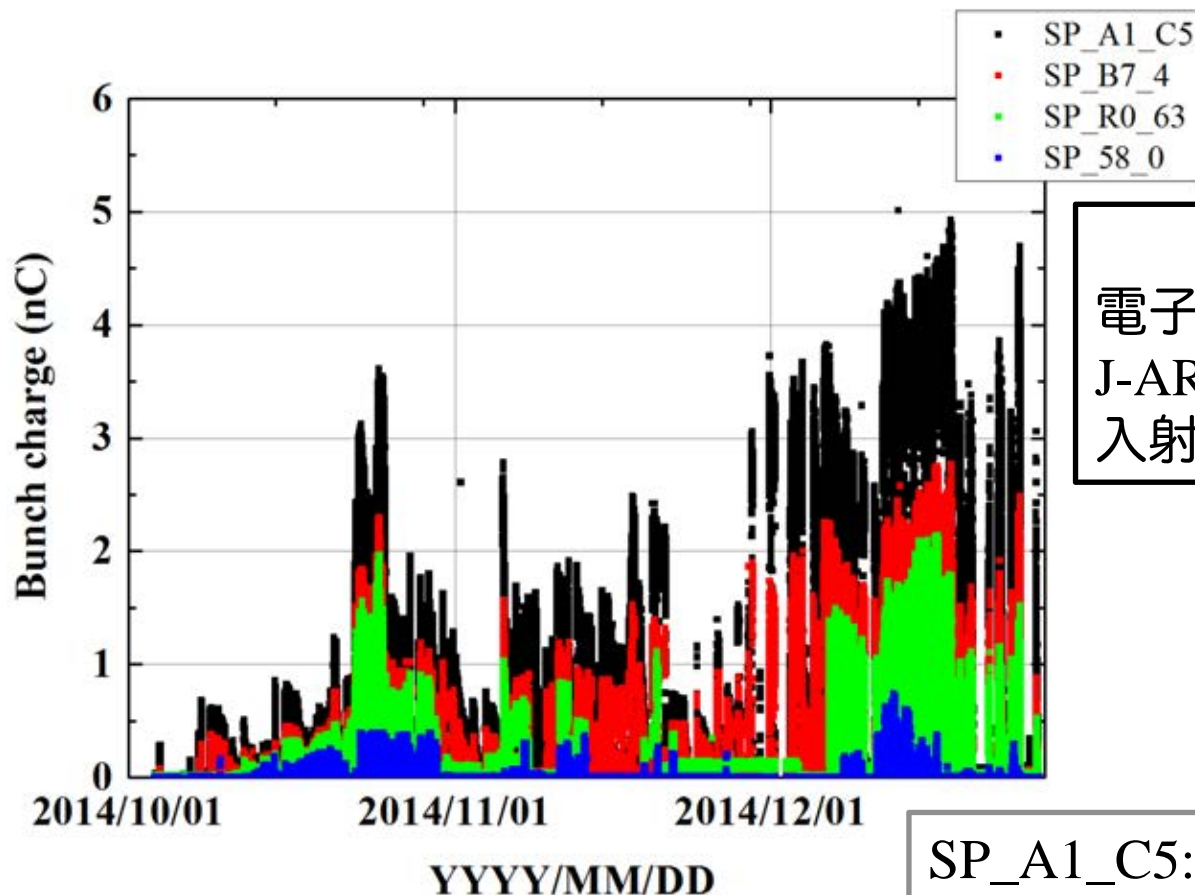



Photo cathode RF gun improvement

- ◆ **Crucial for high-current low-emittance beam**
- ◆ **New Ir5Ce cathode and new cavity QTWSC were successful**
- ◆ **Basic features were confirmed at 2 ~ 5 Hz**
- ◆ **Expect beam parameter and stability performance at 50 Hz, with multi-pass amplifiers and cooling system**
- ◆ **Resolved the issue of oscillator synchronization**
- ◆ **Staged laser system improvements with beam measurement system**

バンチ電荷量の履歴



最大達成電荷量

電子銃下流：	5 nC
J-ARC出口：	2 nC
入射器終端：	0.74 nC

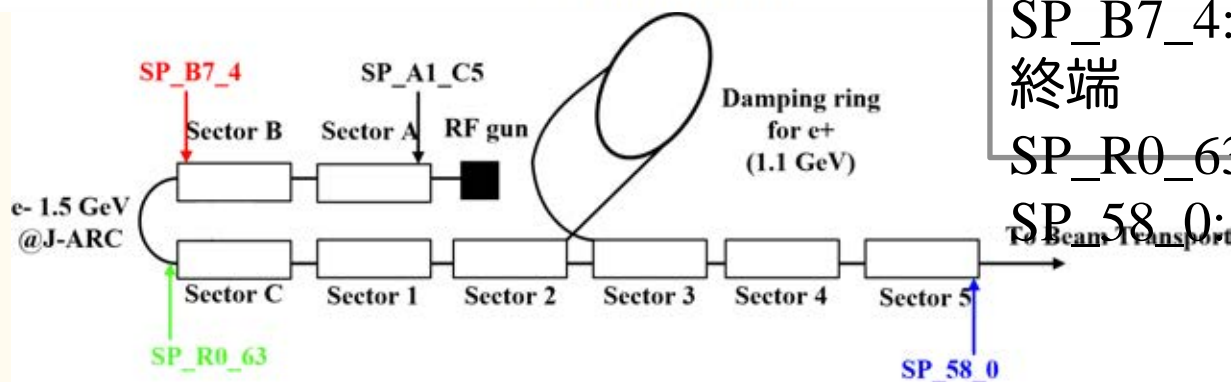

SP_A1_C5: 電子銃直後
 SP_B7_4: Bセクタ
 終端
 SP_R0_63: J-ARC出口
 SP_58_0: 入射器終端

バンチ電荷量安定性の改善

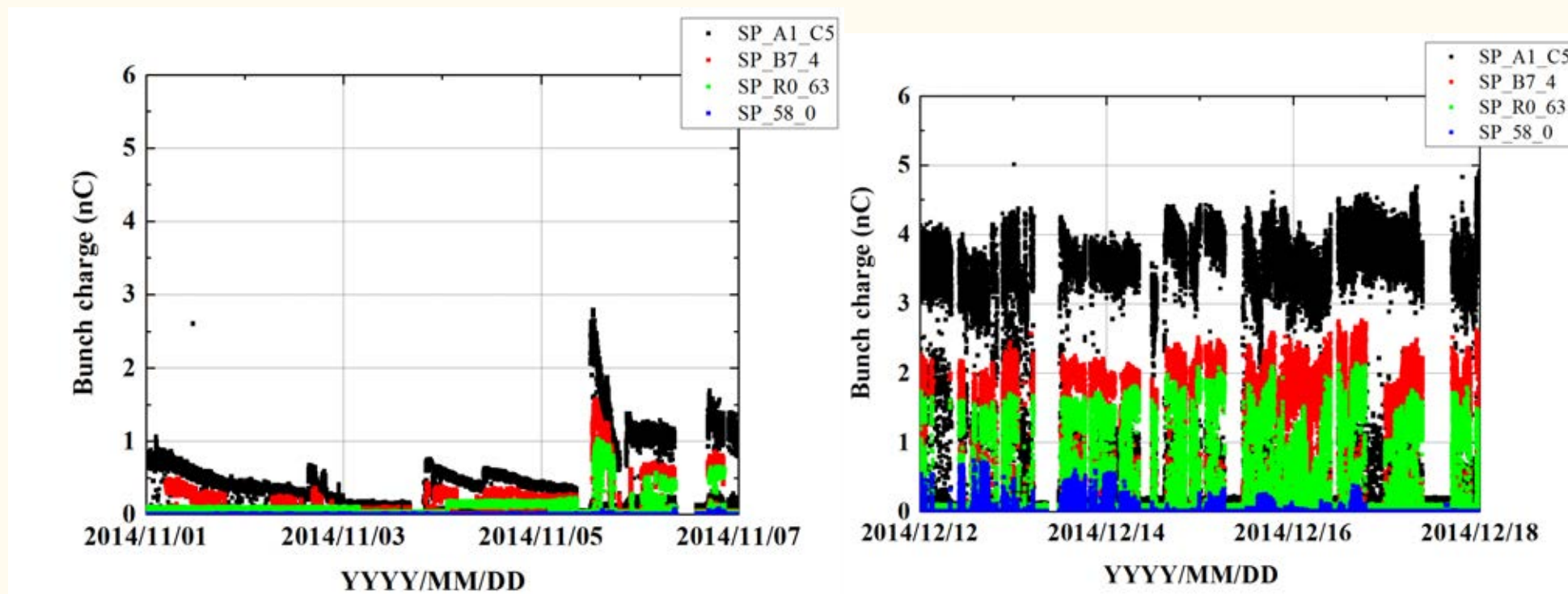

ビーム軌道の例

PFトップアップ入射を継続しつつ，RF電子銃スタディをおこなっている。3セクタ以降は，PFビーム用パラメタを使用。

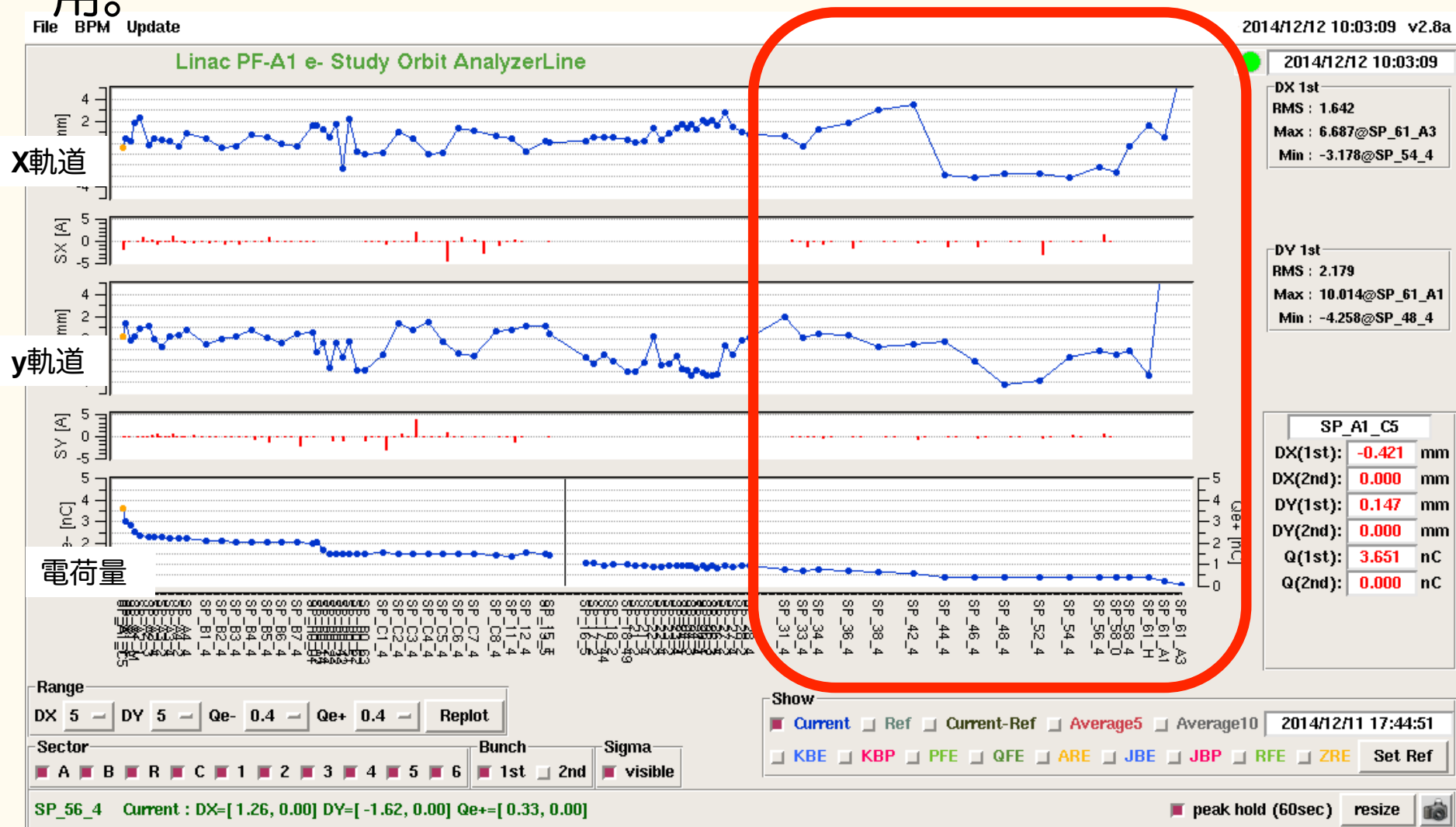



A1 部 Dispersion (2014/11/26) の測定結果

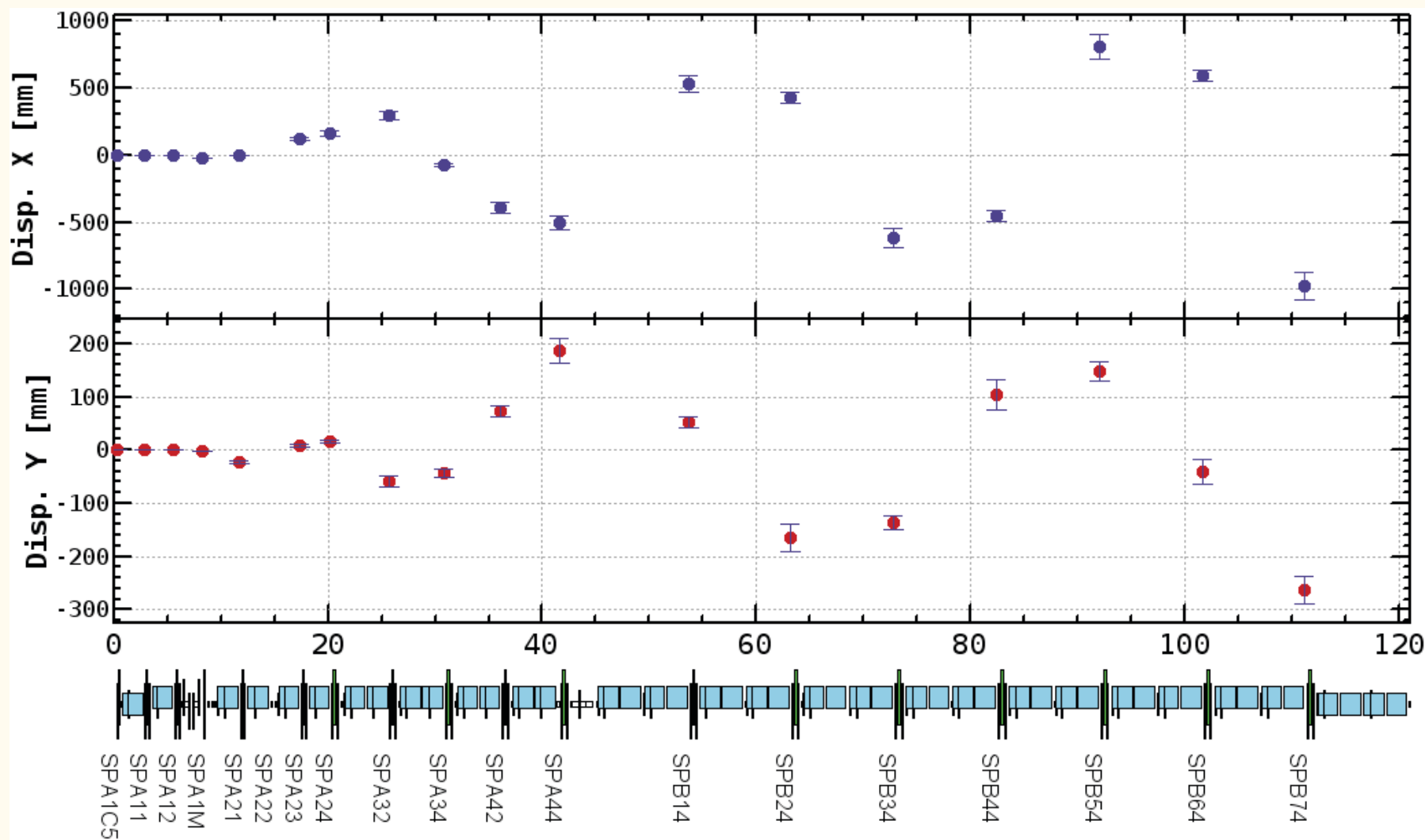

シミュレーション2

- 測定値を再現するようなBMA*の曲げ角をSADのマッチングで探す。

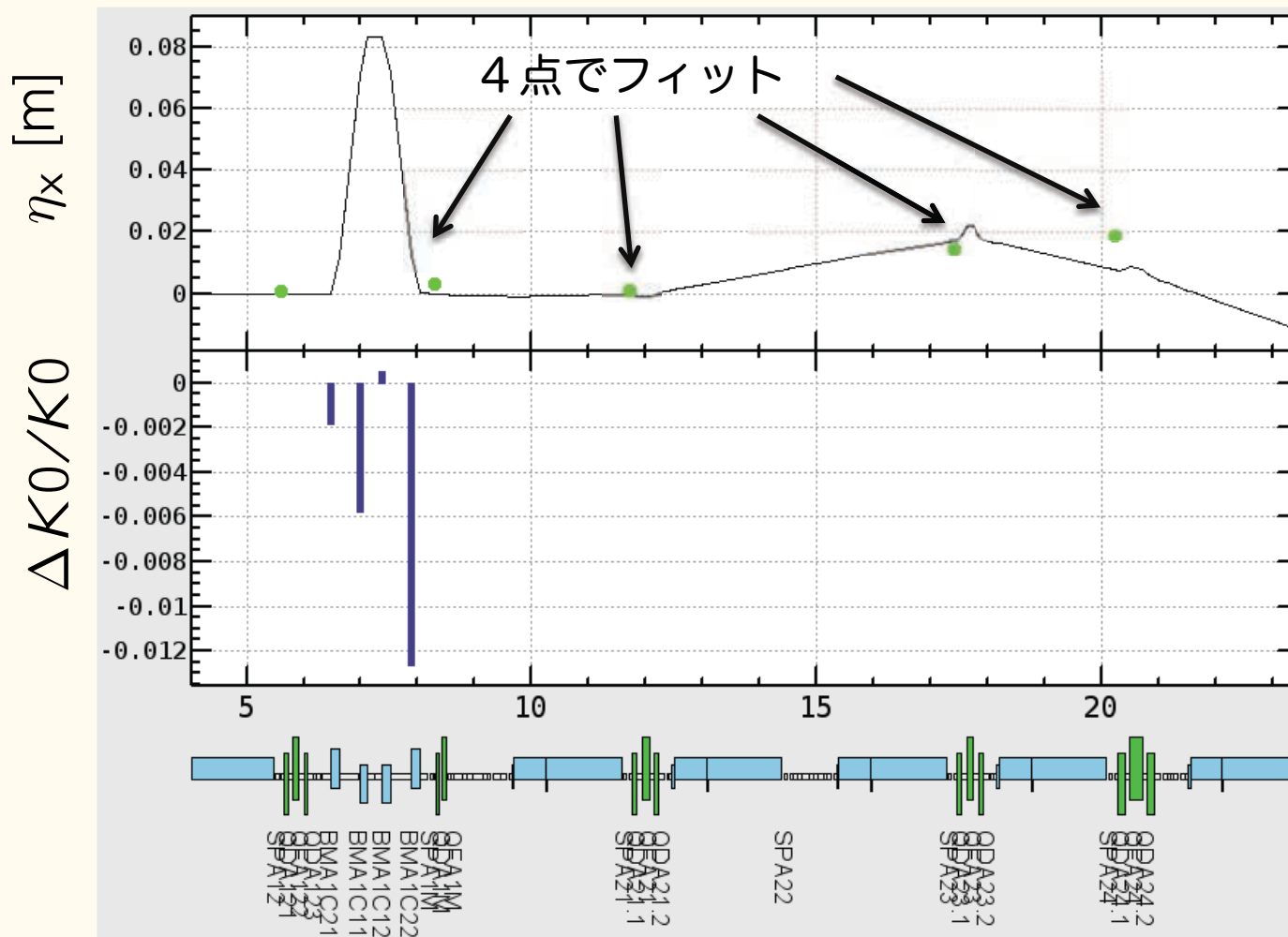

- うまく収束しない。



2014.10.10 A1-A2 測量結果 [PD_A2_U - PD_A2-D 基準]

- PD平均 [A2]
- 加速管 [A1]
- QM測定 1回目 [A2]
- 基準レール [A1]
- QM測定 [A1]
- A1架台東端 [A1]
- 加速管 [A2]
- RF-Gun [A1]

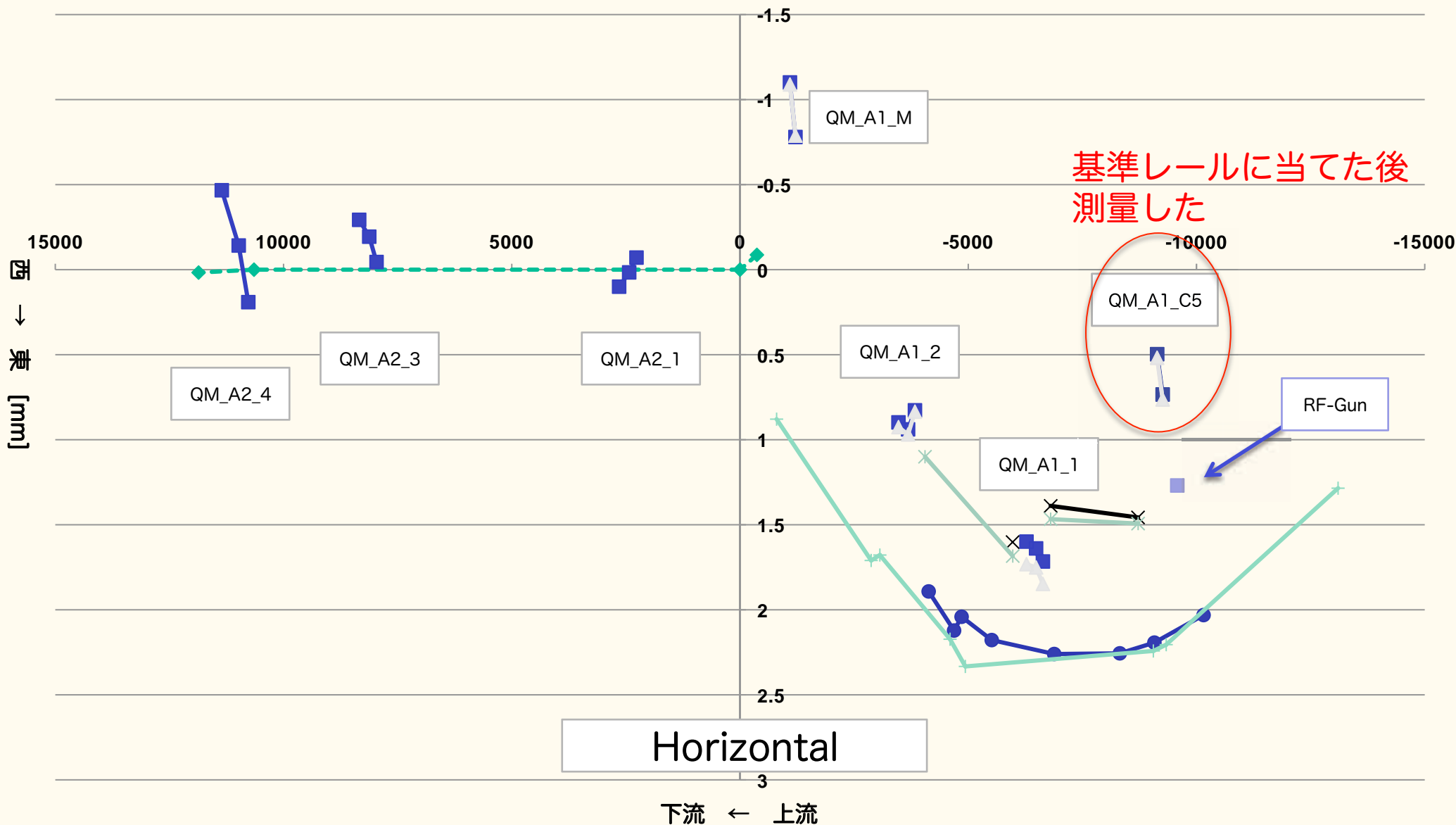



2014.10.10 A1-A2 測量結果 [PD_A2_U - PD_A2-D 基準]

- PD平均 [A2]
- 加速管 [A1]
- QM測定 1回目 [A2]
- 基準レール [A1]
- QM測定 [A1]
- A1架台東端 [A1]
- 加速管 [A2]
- RF-Gun [A1]

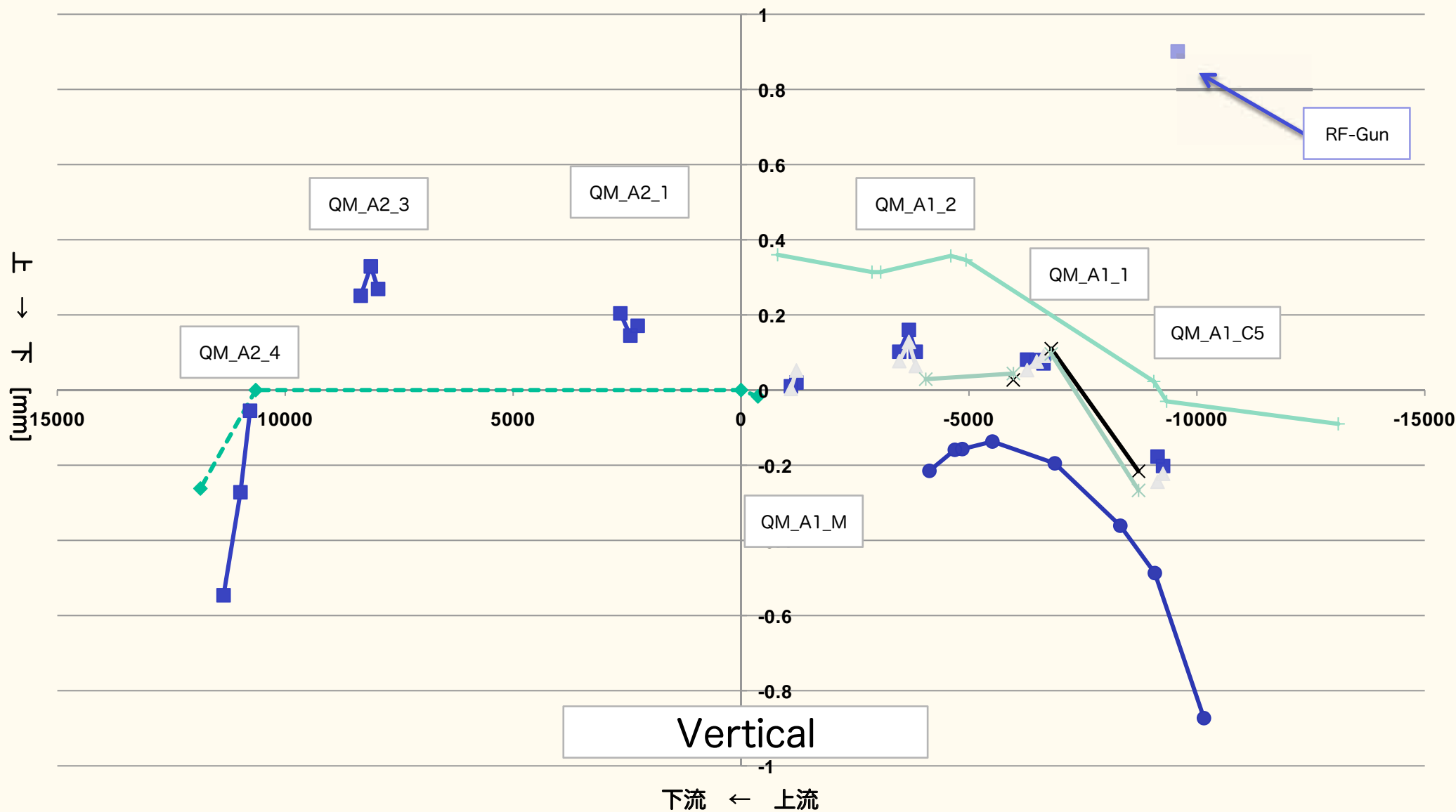

Cathode 面の影響

F. Miyahara

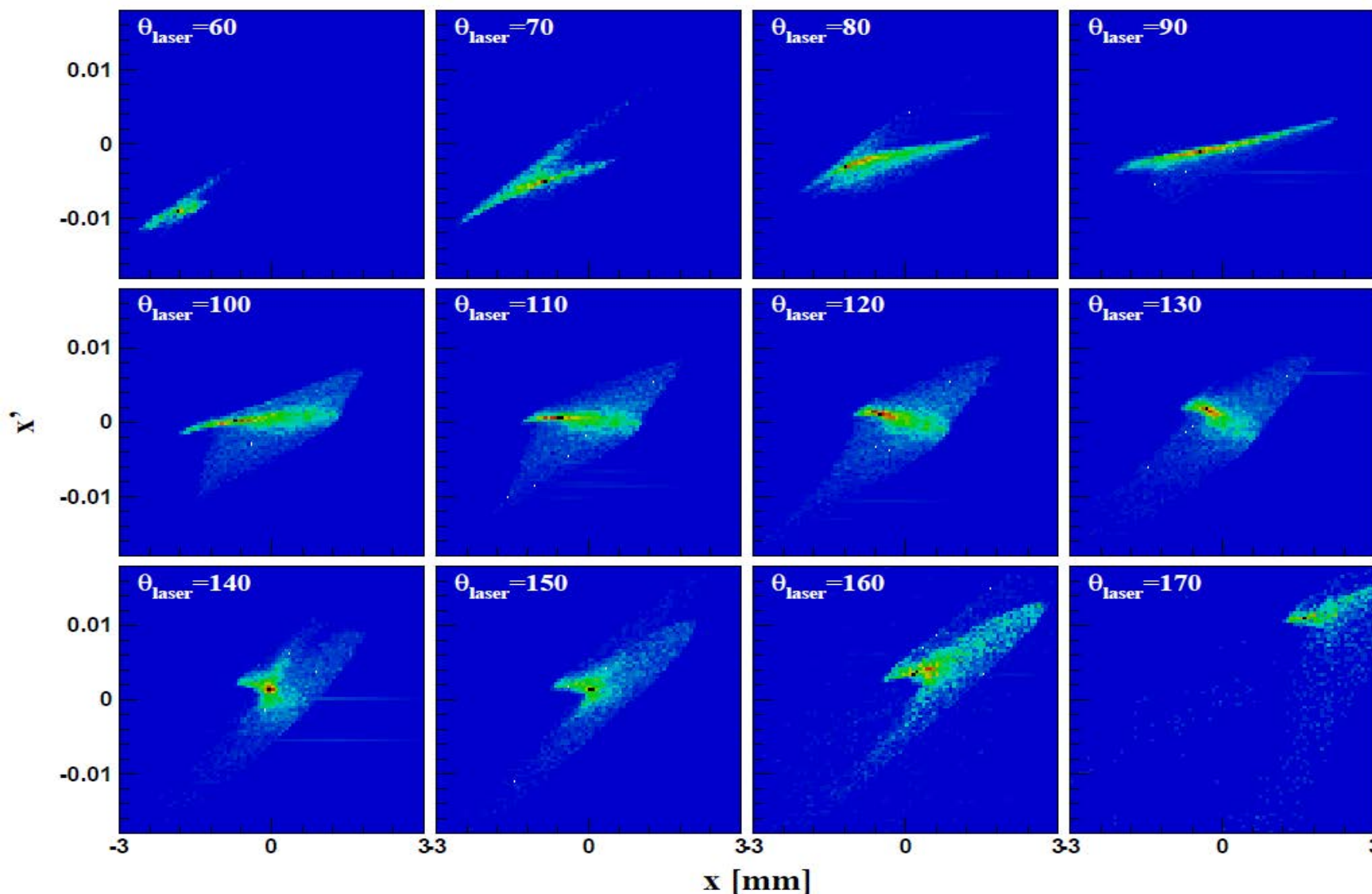

初期分布：
 横方向：
 カソード面で一様
 縦方向：
 矩形、
 パルス幅 30 ps、
 入射角度60

・初期位相が 10° 変わると横方向の位相空間分布が変わる=レーザーのタイミングに敏感（電子銃内部での収束力は位置、時刻によって変動するので分布が変化すれば出口での位相空間分布も変化してしまう）

ターゲット周辺の軌道

不自然な水平軌道 (要アライメント確認)

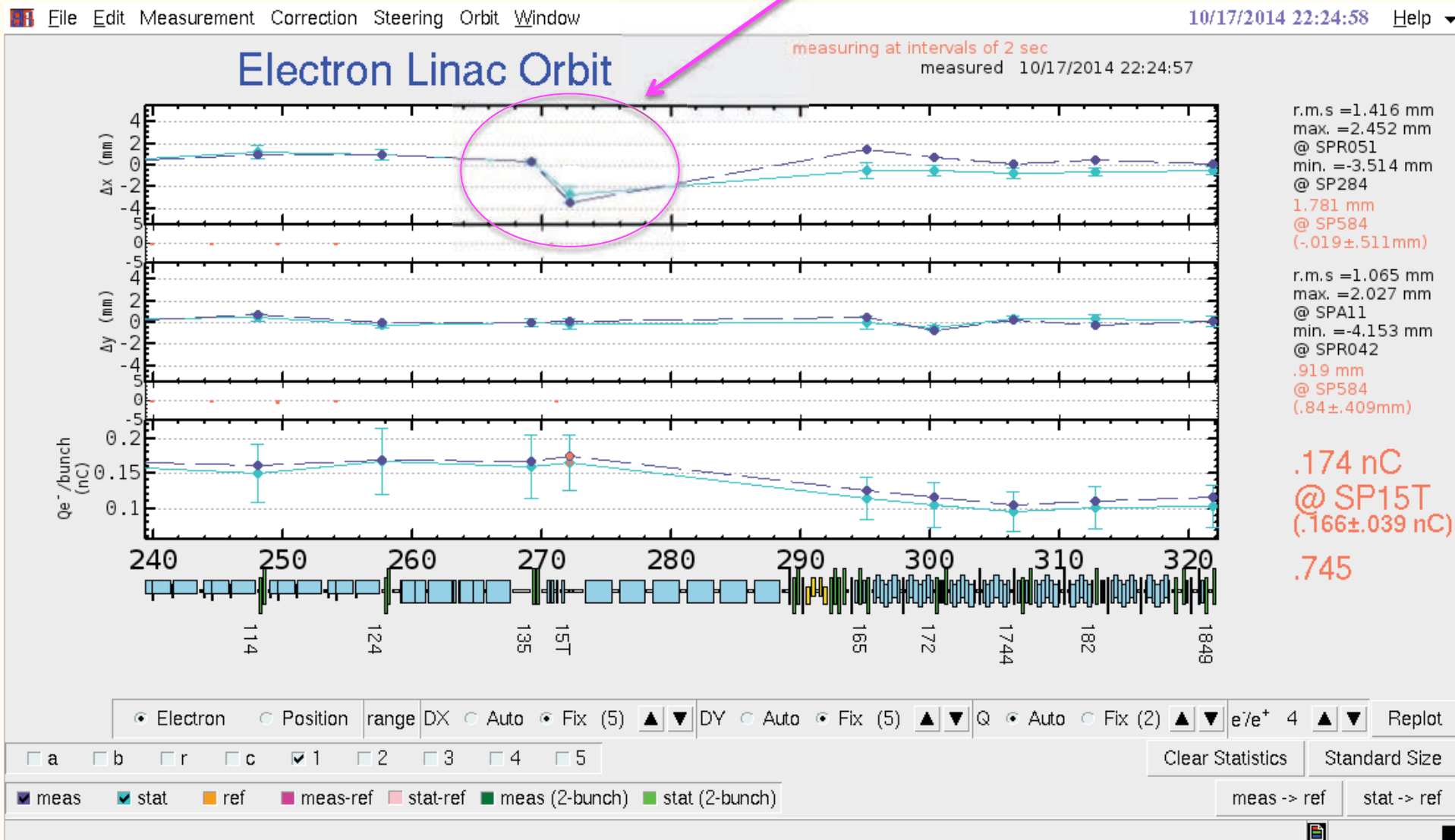

R0 ARC Dispersion測定：Trackingとの比較

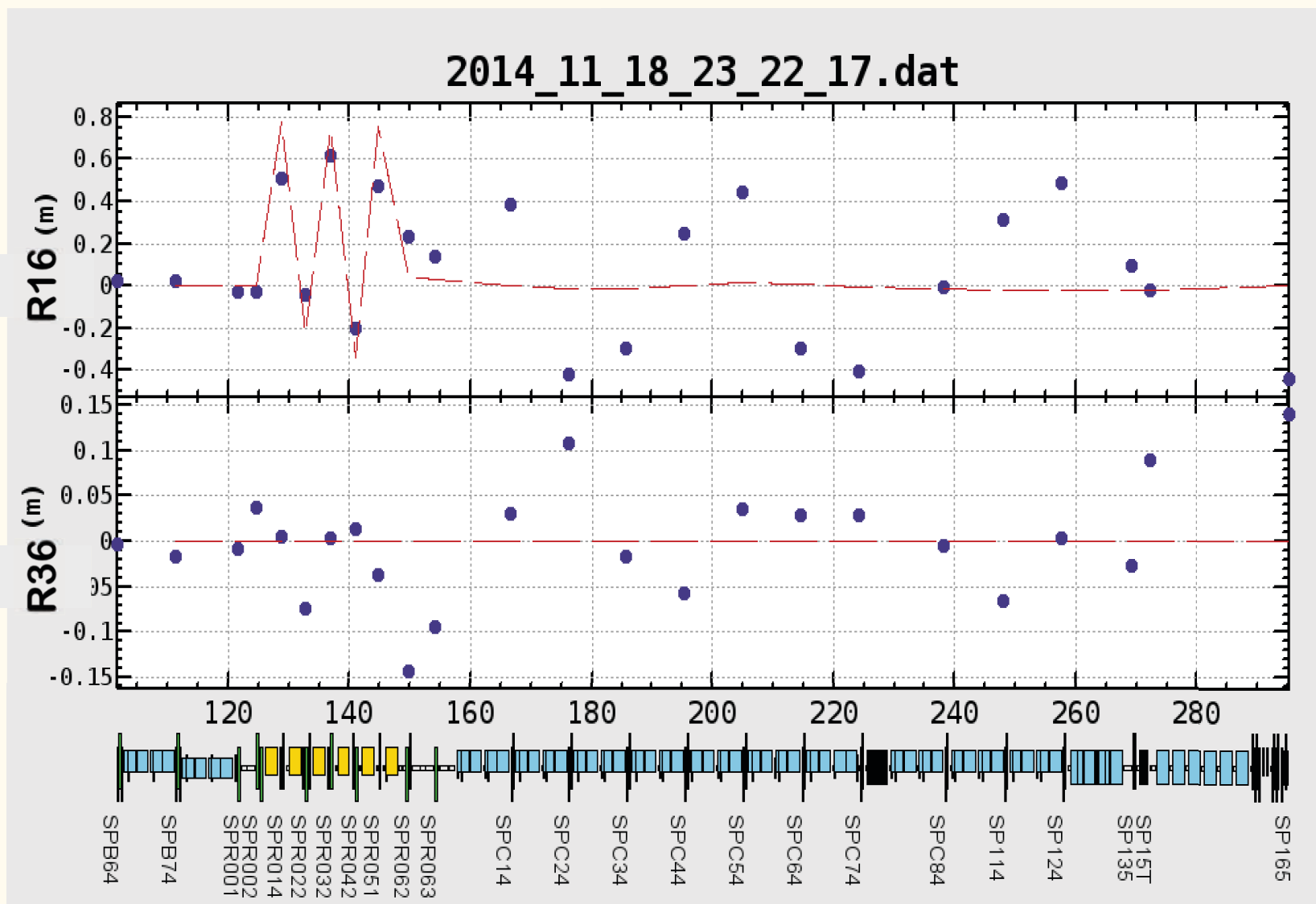



電子ビームコミッショニング

項目	設計値	現状
バンチ電荷量 (nC)	5	5.01 (電子銃直後) 0.58 (入射器終端)
ビームエネルギー	7	7.5
入射器終端でのエミッタンス (mm·mrad)	50/20 (Hor./Ver.)	20/7 (Hor./Ver.) (@A1 unit)
電荷量安定性 (%)	2.5 (KEKB)	10 ~ 20
バンチ圧縮 (A1ユニット) (ps)	30 -> 10	10 ~ 15
バンチ圧縮 (J-ARC) (ps)	10 -> 5	n/a
ビーム分布 (縦方向)	一様分布	n/a
エミッタンス保存	“J-ARCバンチ圧縮” + “オフセットインジェクション”	n/a
最大ビーム繰り返し (Hz)	50	25
最大バンチ数 (rfパルス当たり)	2	2
ビーム入射	Simultaneous top-up	n/a



今季の Commissioning

◆ コミッショニングツール群の整備

- ❖ ワイヤスキャナ

- ❖ トリガ同期カメラおよびスクリーンモニタによるQスキャン測定

- ❖ マッチングソフトウェア

◆ 課題

- ❖ 入射部のアライメント

- ❖ A1シケイン, J-ARCでのビームロス低減 (アライメント再確認)

入射運転に向けて

- ◆現状で定常運転向けの **Beam** が完成しているわけではない
- ◆開発は継続する必要があるが、運転向けの体制を考える
- ◆**Phase-1** では **Beam requirement** は厳しくない
- ◆放射線施設検査を 5-6 月に控えている
- ◆RF 電子銃と熱電子銃の併用を進める



Staged Radiation Control License towards SuperKEKB

- ◆ **Two licenses were approved in June 2014**
- ◆ **[1] Beam diagnostic station at #A2 just after gun**
 - ❖ **for 1250nC/s at 50Hz 2bunches**
- ◆ **[2] Beam dump at #28 just before damping ring**
 - ❖ **for 10nC/s with positrons**
- ◆ **Radiation measurements especially at positron generator**
 - ❖ **Indispensable to estimate radiation at ≥ 100 times higher beam**
- ◆ **Both approved**
- ◆ **Soon apply for the next license at \sim May.2015**



現状

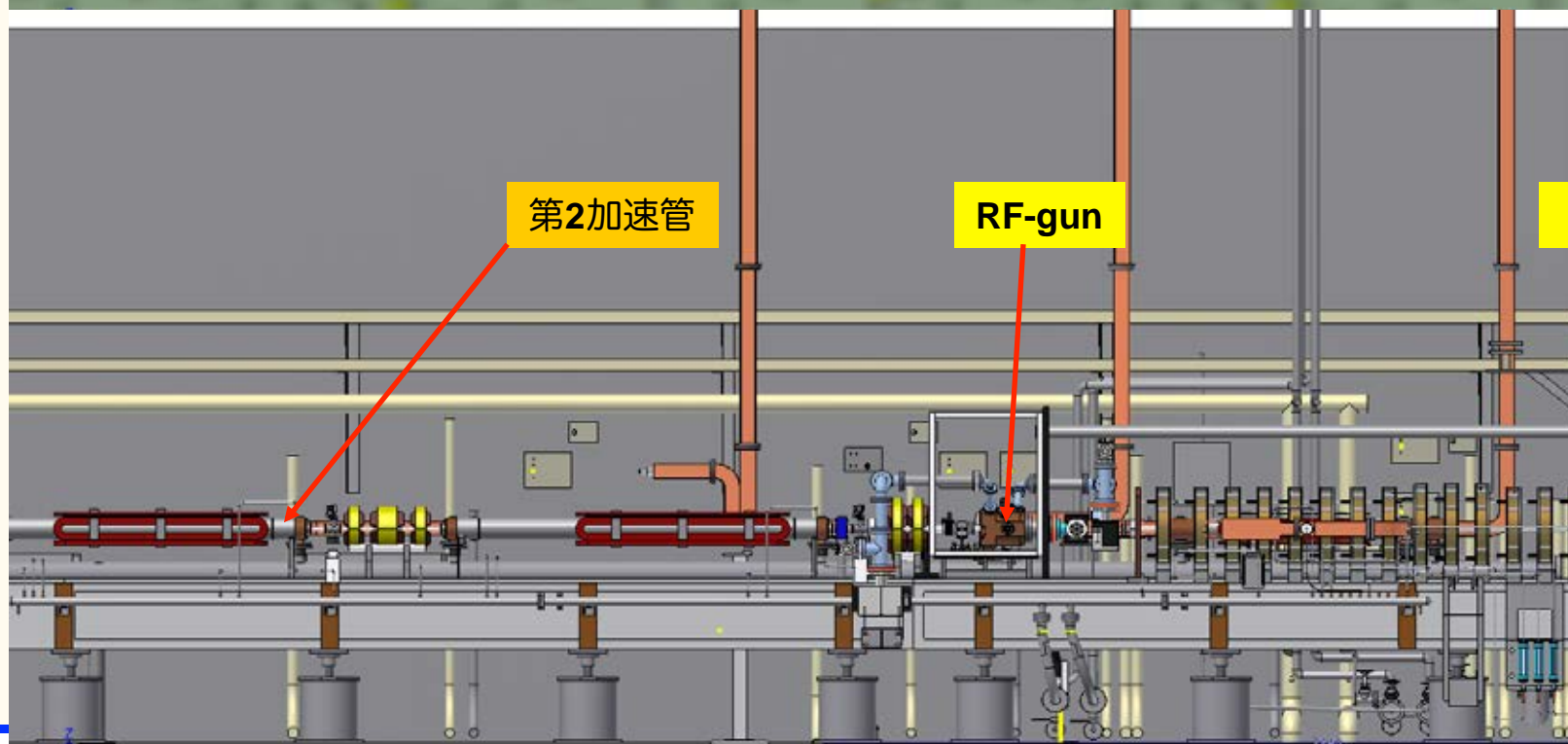
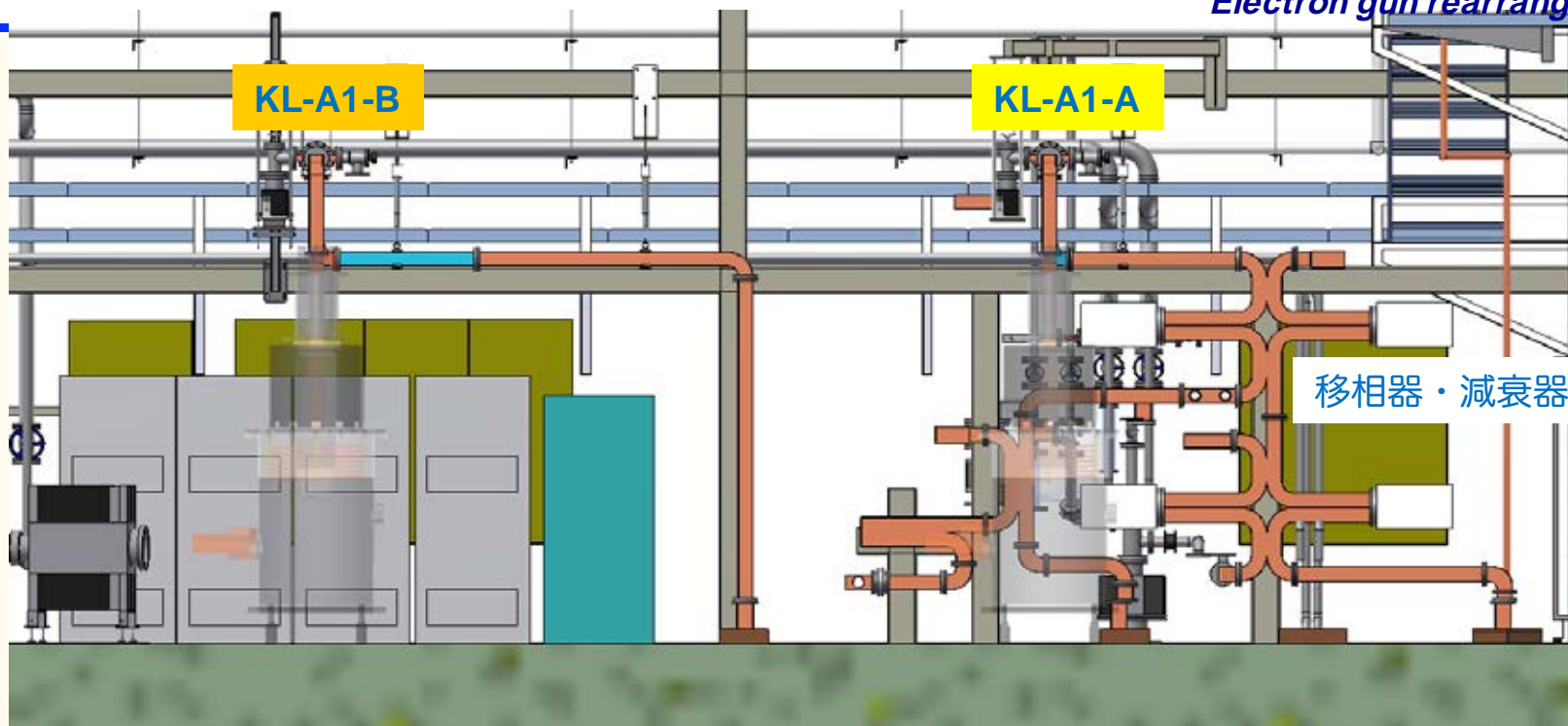



現状

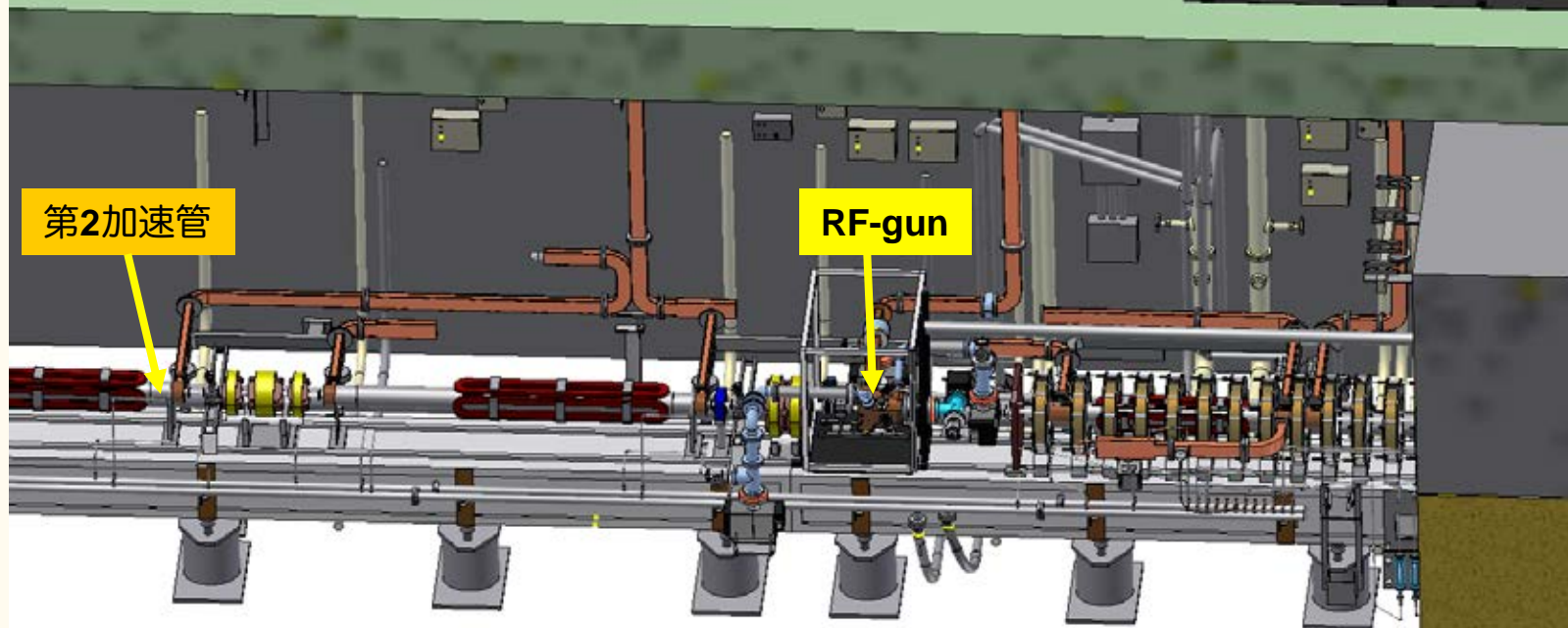
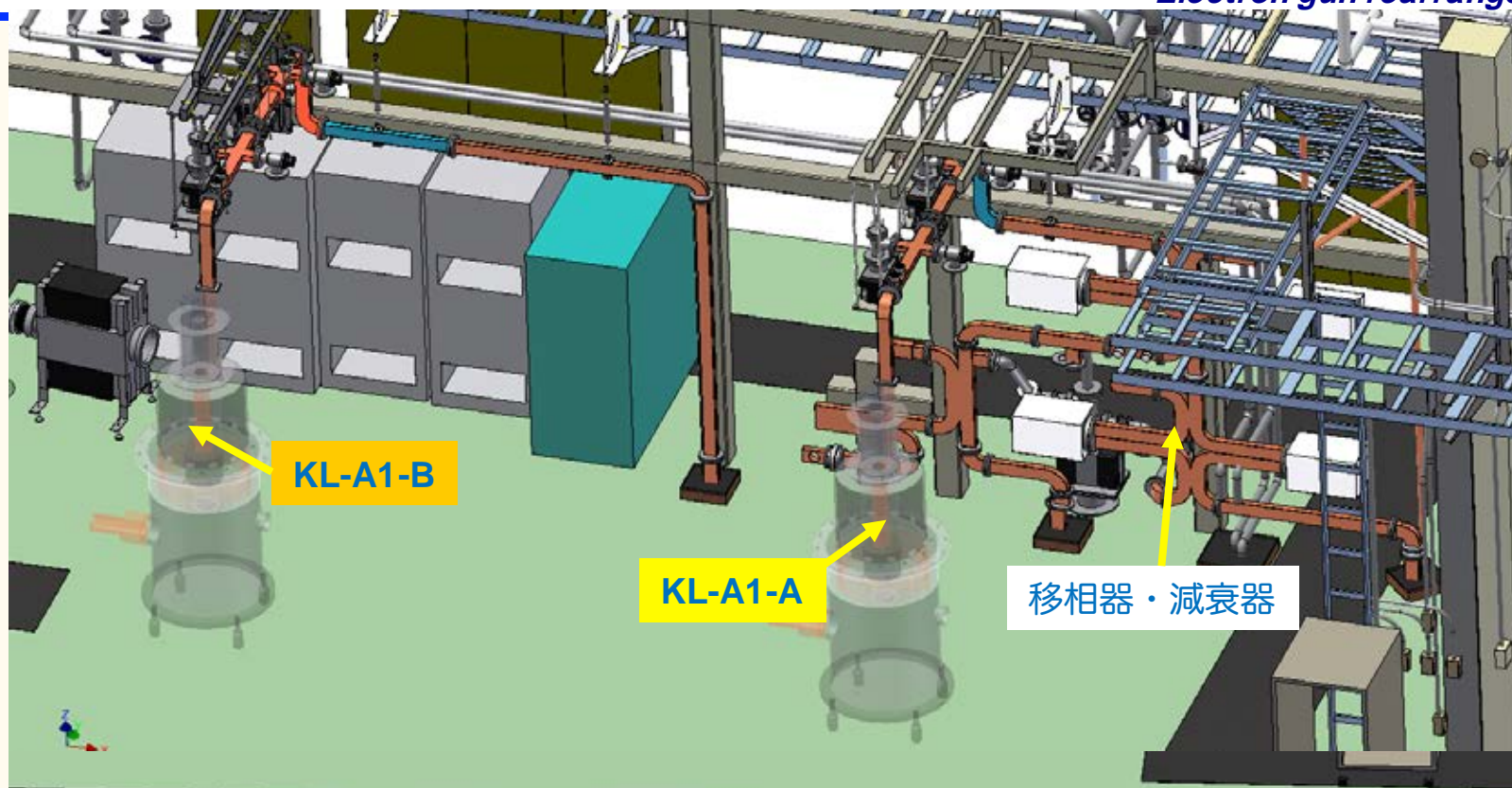

熱電子銃と RF Gun 同時設置 1

KL_A1_B より RF 供給

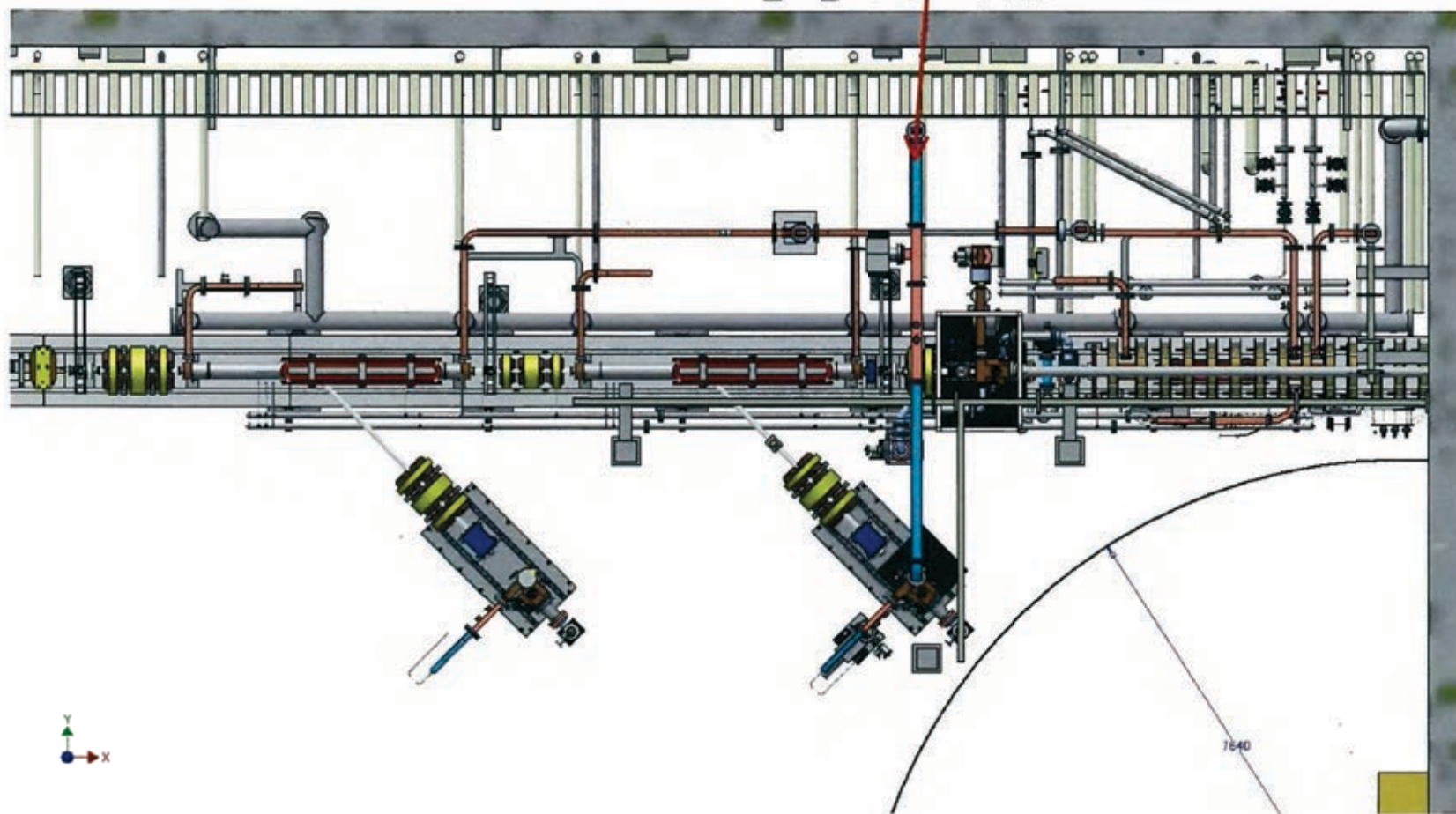

4

熱電子銃と RF Gun 同時設置 2

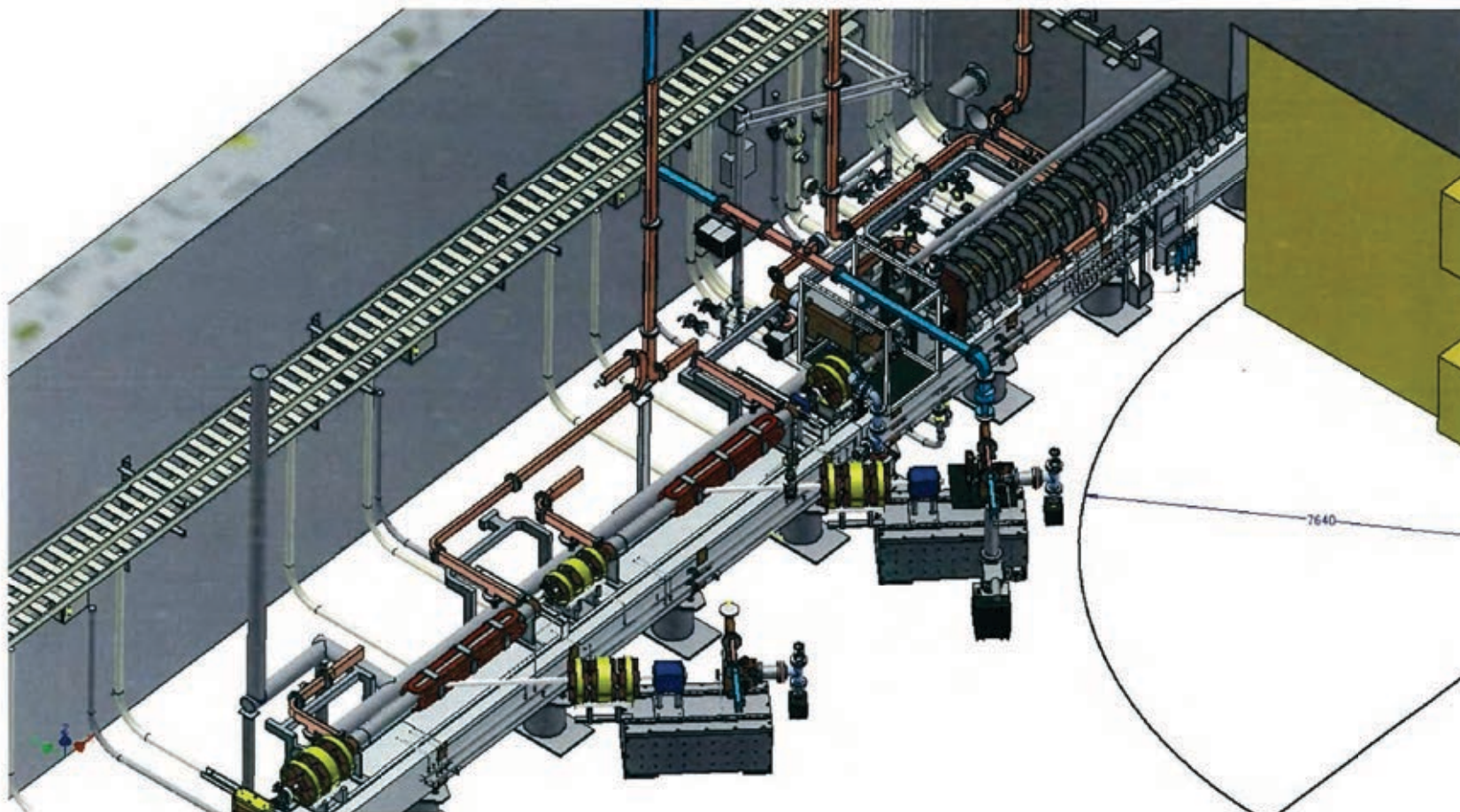

5



改造案

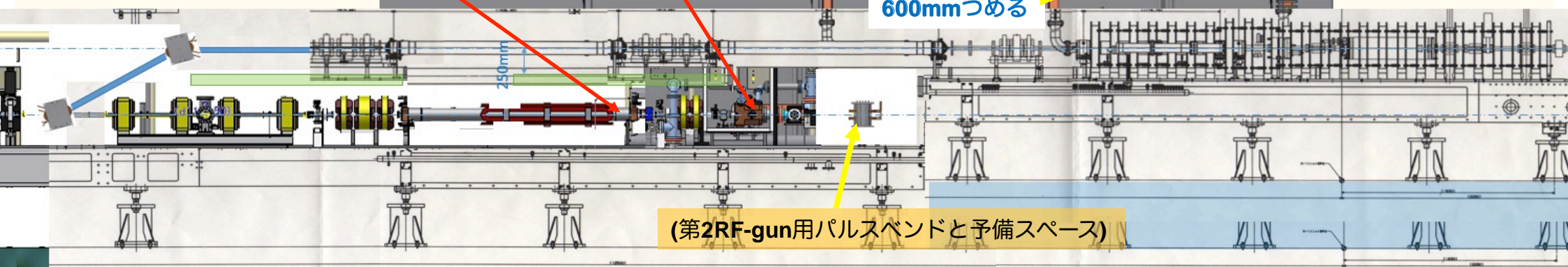
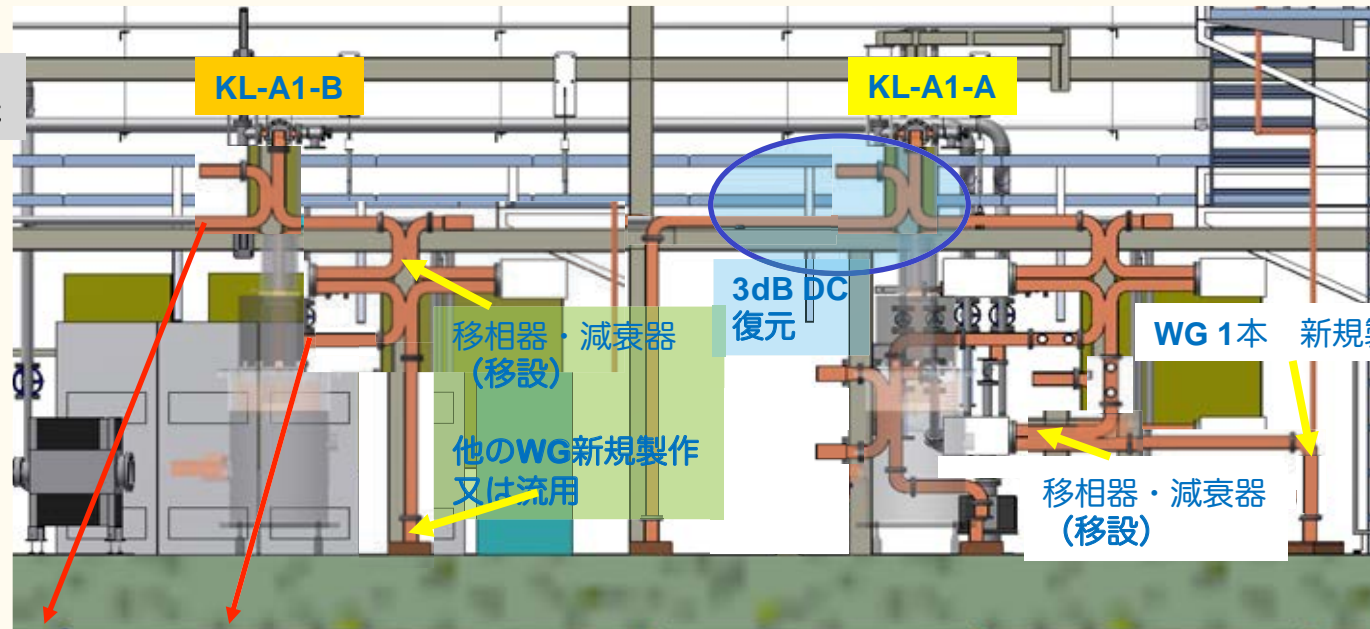



改造案2

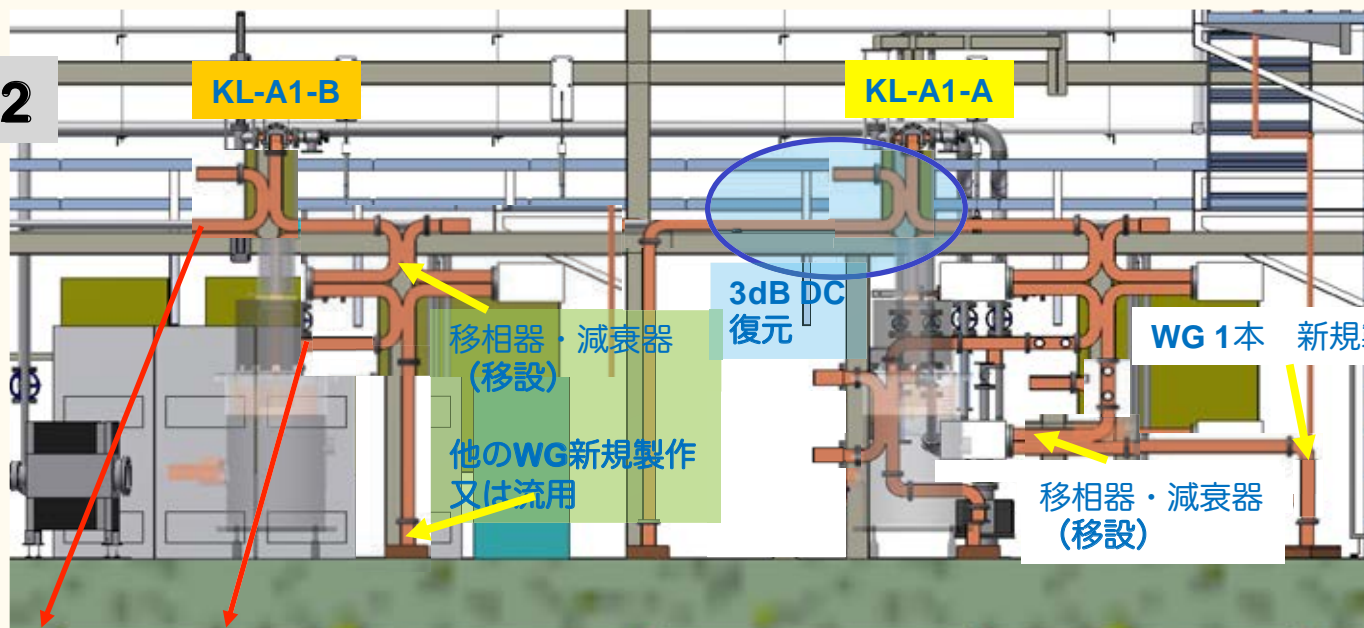

加速管 1 本 (第2RF-gun) 第1RF-gun 加速管 2本 Buncher Pre-buncher

WG 3本を 600mmつめる

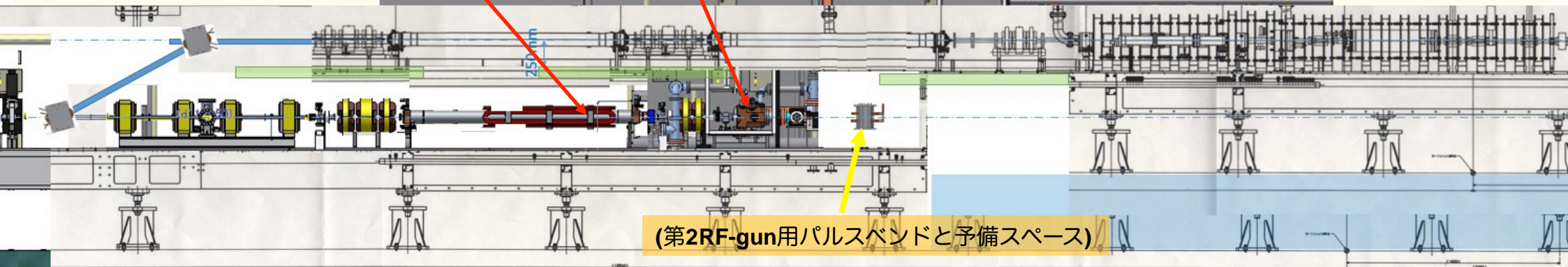

(第2RF-gun用パルスバンドと予備スペース)



Summary

- ◆ **Steady progress towards first MR injection in 2015**
- ◆ **Finishing earthquake disaster recovery in 2014**
- ◆ **Will make staged improvements before 2017**
- ◆ **Will balance between final beam quality and staged operation**
- ◆ **Will select optimized route depending on available resources**
 - ❖ **Incorporate thermionic gun as well as RF gun**

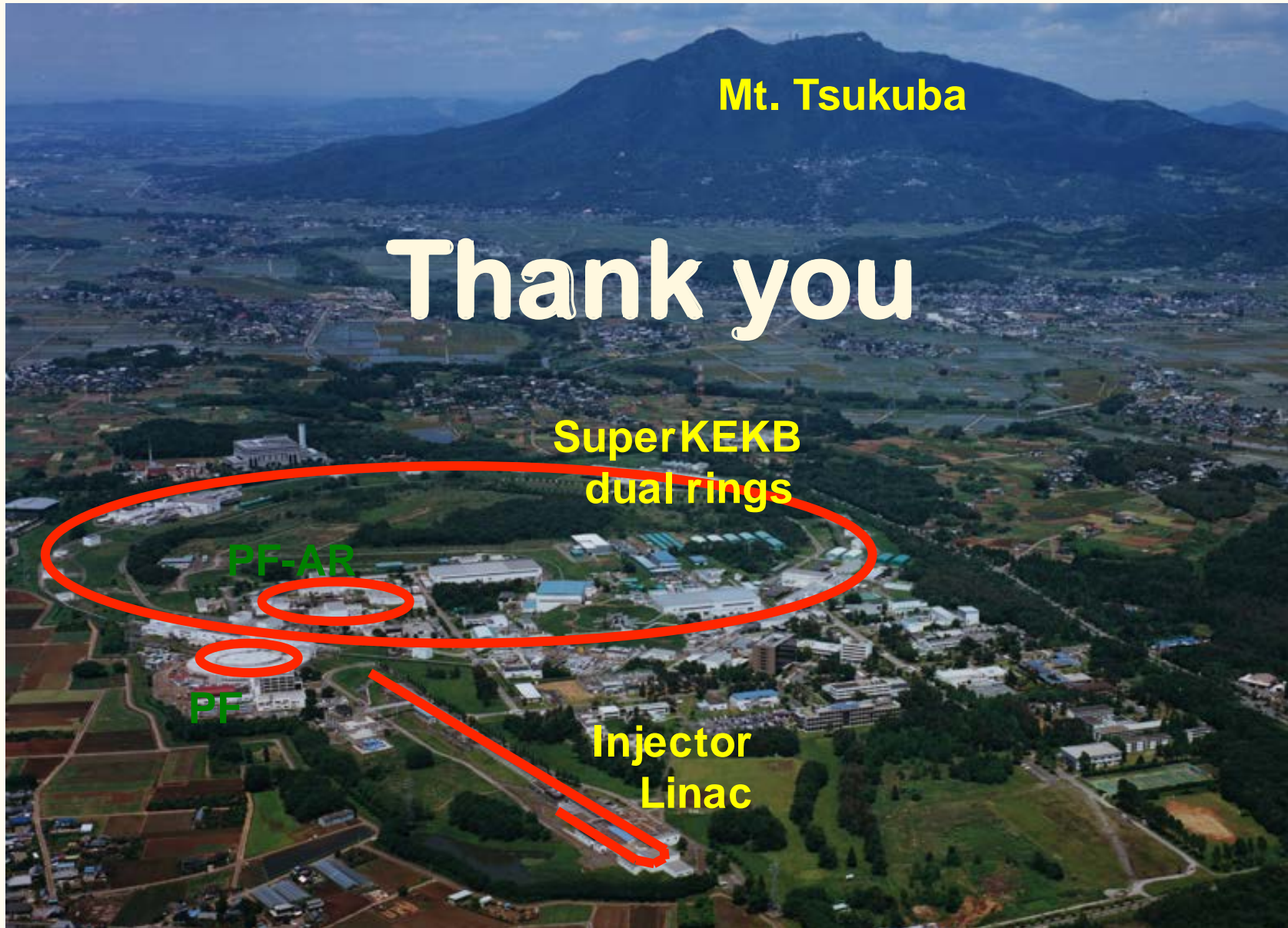

Mt. Tsukuba

Thank you

SuperKEKB
dual rings

PF-AR

PF

Injector
Linac





Emittance Preservation and Alignment

- ◆ **If Device is off center of the beam**
 - ❖ Focusing magnet (quad) kicks the beam bunch
 - ❖ Accelerating structure (cavity) excites wakefield, to bend the tail
- ◆ **Distorted bunch in banana shape**
 - ❖ Emittance dilution or blow-up, even 100 times larger
 - ✧ Depending on the beam optics and the beam charge
- ◆ **Alignment and orbit correction is crucial to preserve the emittance**

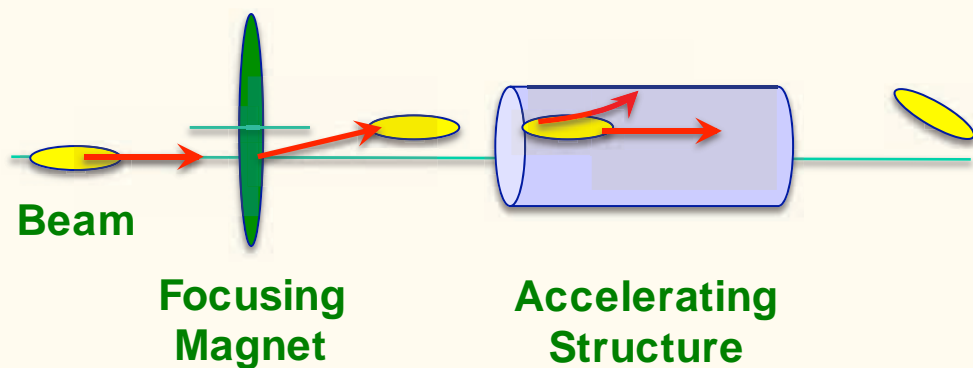

Sugimoto et al.

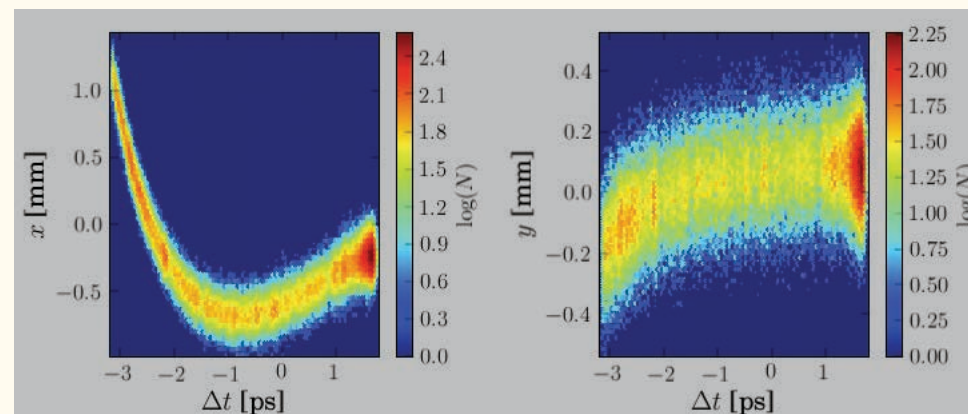

Transverse beam distribution in time direction

Emittance Preservation

- ◆ Offset injection may solve the issue
- ◆ Orbit have to be maintained precisely
- ◆ Mis-alignment should be ≤ 0.1 mm locally, ≤ 0.3 mm globally

Mis-alignment leads to Emittance blow-up

Orbit manipulation compensates it

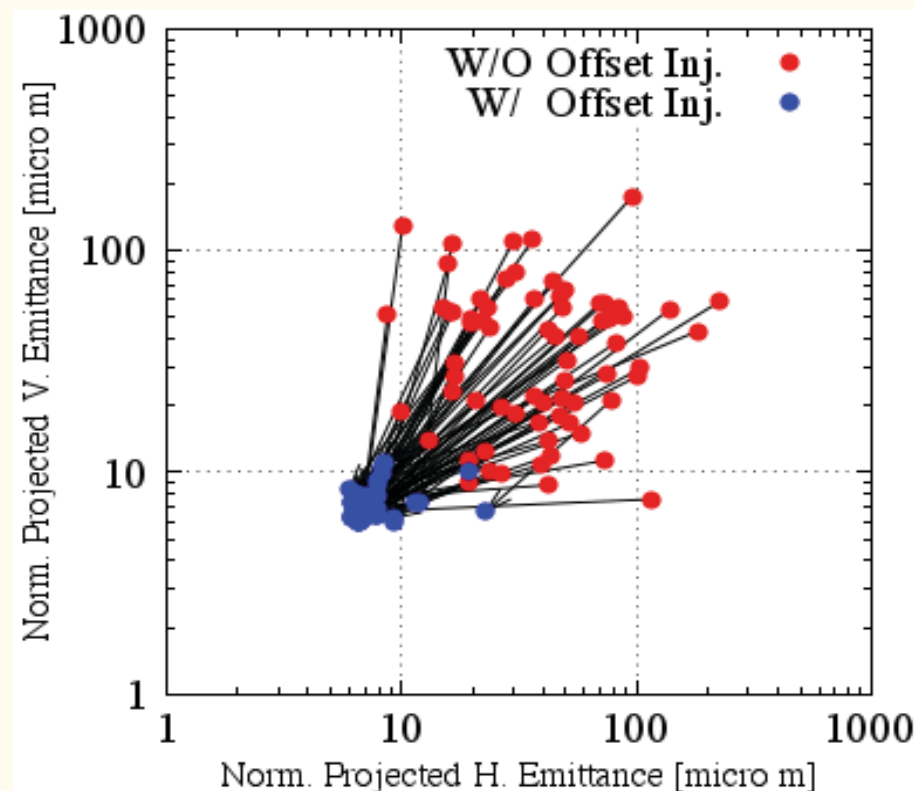
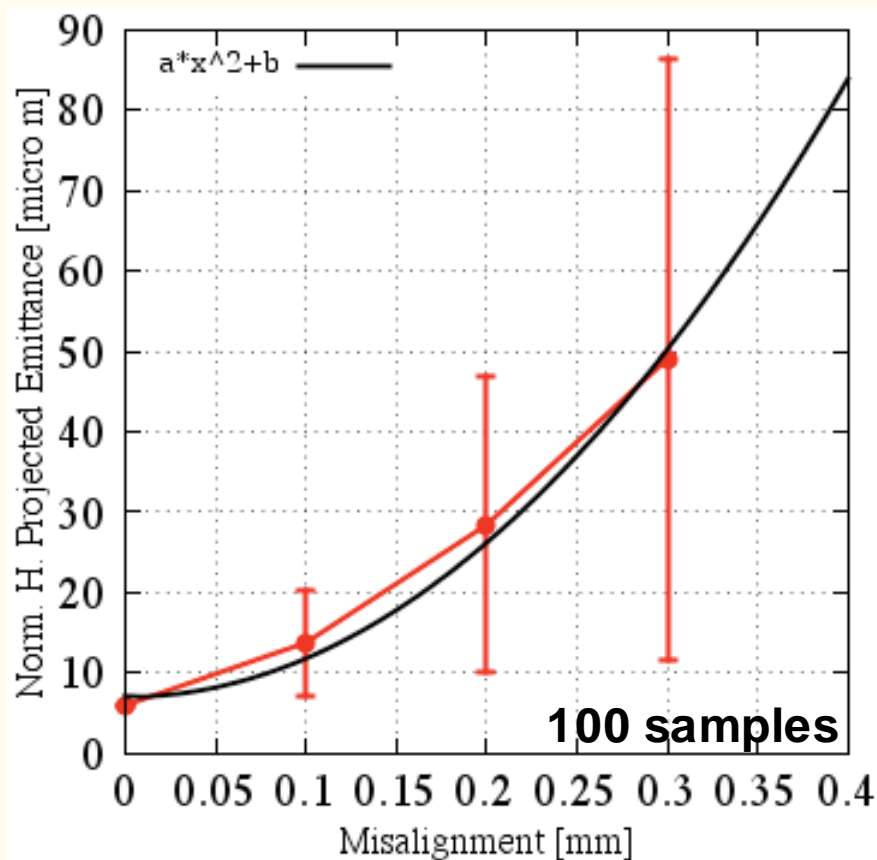

Sugimoto et al.



Pulse-to-pulse modulation

◆ Four PPM virtual accelerators for SuperKEKB project

maybe with additional PPM VAs for stealth beam measurements

based on Dual-tier controls with EPICS and event-system

