

LONGITUDINAL MANIPULATION TO OBTAIN AND KEEP THE LOW EMITTANCE AND HIGH CHARGE ELECTRON BEAM FOR SUPERKEKB INJECTOR*

Mitsuhiro Yoshida[#], Naoko Iida, Takuya Natsui, Yujiro Ogawa, Satoshi Ohsawa, Hiroshi Sugimoto, Lei Zang, Xiangyu Zhou, KEK, Ibaraki, Japan

Abstract

The design strategy of SuperKEKB is based on the nano-beam scheme. The dynamic aperture decreases due to the very small beta function at the interaction point.

Thus the injector upgrade is also required to obtain the low emittance and high charge beam corresponding to the short beam life and small injection acceptance of the SuperKEKB ring. The required beam parameters are 5 nC, 20 mm mrad and 4 nC, 6 mm mrad for the electron and positron respectively. For the electron beam, we installed new photocathode RF-Gun with the focusing electric field and temporal adjusting laser system. Further the projected emittance dilution in the LINAC is an important issue for the low emittance injection. The longitudinal bunch length and shape is an important key to avoid the space charge effect and the emittance dilution. The longitudinal manipulation using the temporal adjusting laser system, the bunch compression and the bunch flip will be presented. Further the longitudinal bunch measurement will be also presented.

REQUIREMENTS

The injector upgrade as shown in Fig 2 is required for the SuperKEKB injection due to the small dynamic aperture and the short life time of the ring. The bunch charge must increase up to 5 times higher than KEKB and the lower emittance is required around 20 mm mrad. Further the small energy spread of around 0.1 % is required in the condition of higher bunch charge for the synchrotron injection of the HER of the SuperKEKB.

Table 1: Required parameters for SuperKEKB

	KEKB(e ⁺ /e ⁻)	SuperKEKB(e ⁺ /e ⁻)
Beam Energy	3.5 / 8.0 GeV	4.0 / 7.0 GeV
Bunch Charge	1.0 / 1.0 nC	4.0 / 5.0 nC
Normalized vertical Emittance (1 σ)	2100 / 300 mmmrad	6 / 20 mm mrad
Energy Spread	0.1 %	0.1 %

PHOTOCATHODE RF-GUN

The initial emittance at the electron gun is determined by the space charge effect and the RF emittance.

The photocathode RF-Gun is required to generate such

low emittance of lower than 10 mm mrad for the high charge of 5 nC. We developed the new advanced RF-Gun with the focusing electric field to keep the beam size against the space charge[1]. In this design, we chose the electric field of around 80 MV/m on the cathode for the long stable operation. Thus the bunch length must be longer than 20 ps to obtain the charge of 5 nC and the transverse emittance of 10 mm mrad.

TRANSVERSE AND LONGITUDINAL WAKEFIELD

The transverse wakefield is main source of the emittance dilution for the high bunch charge of 5 nC after the beam orbit is well corrected in the LINAC beam optics. And the energy spread is determined by the longitudinal wakefield strength. The smaller alignment tolerance and the shorter bunch length can reduce the transverse wakefield strength. However the shorter bunch length causes the stronger longitudinal wakefield.

Transverse Wakefield and Projected Emittance

Figure 1 shows the analytical calculation of the projected emittance in several case of the bunch length and the alignment error. The bunch length of 4 ps and 10 ps are required for the alignment error of 0.3 mm and 0.1 mm respectively from Fig. 1. Since our normal bunch length is 10 ps, we are working to reach the alignment error of 0.1 mm for each local section which consists of 8 units. However it seems very hard to keep this small alignment error in our old support structure and the frequent earthquake. Thus we have to consider the 4 ps option for the alignment error of 0.3 mm.

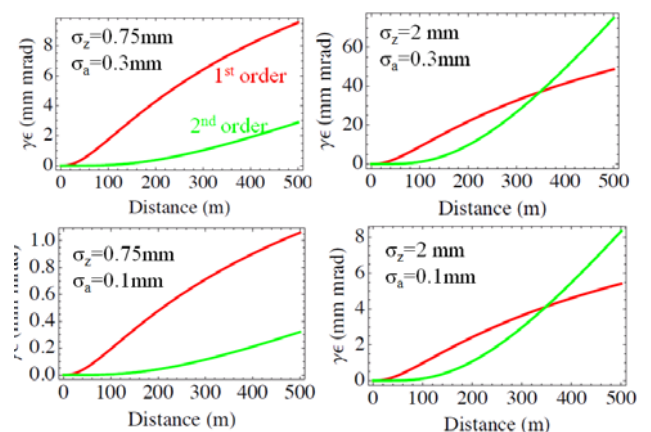

Figure 1: Projected emittance.

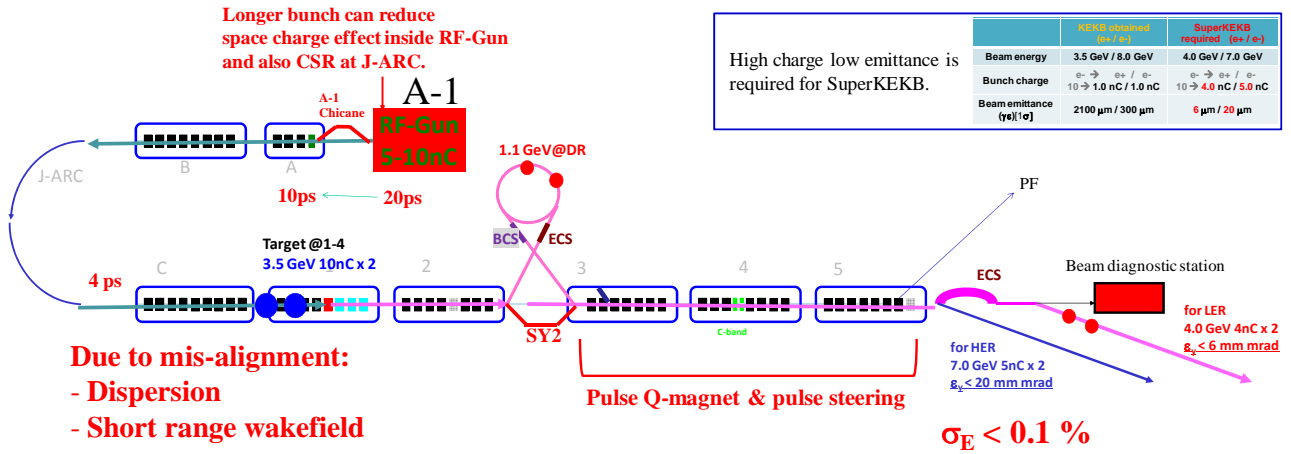

Figure 2: KEKB Injector upgrade to obtain the low emittance and the high charge for SuperKEKB injection.

Initial offset

The initial offset can compensate the transverse wakefield to recover the emittance dilution. The initial offset is taken as the two steering magnet with 90 degree phase difference of the betafunction for each axis. Figure 3 shows the emittance optimization using the initial offset scan. It is realized using the RF deflector to observe the longitudinal bunch shape.

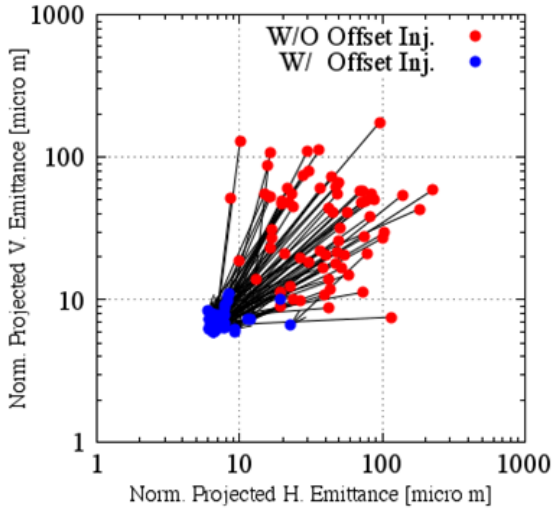

Figure 3: Initial offset to optimise the projected emittance.

Longitudinal Wakefield and Energy Spread

The required energy spread of 0.1 % was achieved for the bunch charge of 1 nC at the previous KEKB operation. However the required bunch charge becomes 5 nC for SuperKEKB and it induces the stronger wakefield. Further the stronger longitudinal wakefield induced by the shorter bunch causes the larger energy spread. Fortunately the energy spread at the optimum RF phase dramatically decreases using the uniform charge density bunch as shown in Fig 3.

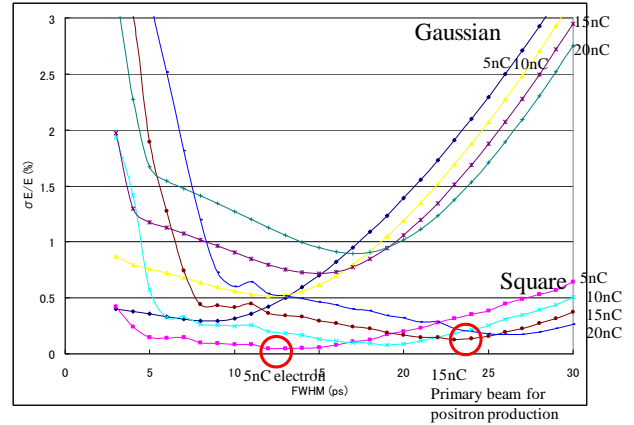

Figure 3: Energy spread vs bunch length.

BUNCH SHAPING AND COMPRESSION

As described before, the shorter bunch length suppresses the emittance dilution due to the transverse wakefield. However it causes the larger energy spread due to the longitudinal wakefield. Also the shorter bunch length requires the deeper RF phase to compensate the longitudinal wakefield and it causes lower accelerating gradient.

Thus the uniform charge distribution must be required for any bunch length to reach the energy spread of 0.1 % at 5 nC operation. Further the another method like the bunch flip is required for the shorter bunch length of 4 ps in cause of the alignment error of 0.3 mm.

Laser System for Photocathode RF-Gun

The laser system with the wideband laser medium is required to adjust the spectral shaping which can convert to the temporal shaping after the pulse stretcher to obtain the uniform charge density. The laser mediums of the Ti-sapphire or the ytterbium (Yb) are the candidates as the

well-established wideband laser system. We chose the Yb medium since it has long fluorescent lifetime which enables to build the all solid state laser pumped by the laser diodes. The Yb-fiber laser system was built for the front end including the oscillator and multi stage pre-amplifier. And the Yb-disk laser system was used for the main amplifier to generate the sub-joule level laser pulse to generate the charge of 5 nC [2].

The slits to adjust the spectral distribution will be installed to this Yb laser system to generate the uniform charge density.

Chicane

The initial bunch length of 20 ps generated by the photocathode RF-Gun will be compressed to 10 ps using the chicane at the low energy section to reduce the emittance dilution due to the transverse wakefield.

Bunch Compression in J-ARC Section

Figure 2 shows the overview of our LINAC. The J-ARC section is placed at the energy of 1.6 GeV. This J-ARC was designed as the isochronous arc. We can change this optics design to the achromatic condition to obtain certain R_{56} to compress the bunch. Figure 4 shows the achromatic design of the J-ARC section and the bunch compression result.

The best bunch length to compress depends on the emittance dilution due to the transverse wakefield induced by the alignment error of the accelerating structure. No compression is required for the alignment error of 0.1 mm. However the bunch length of 4 ps is required for the alignment error of 0.3 mm.

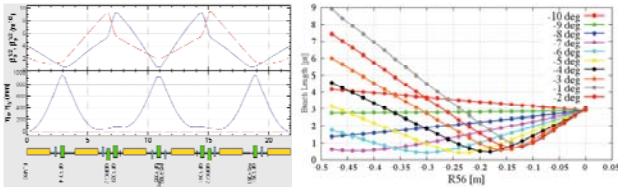

Figure 4: Achromatic design of J-ARC section and .

Bunch Flip

As described in the previous section, the shorter bunch can suppress the emittance dilution due to the transverse wakefield. However it causes the stronger longitudinal wakefield. The RF phase becomes deeper and deeper corresponding to the longitudinal wakefield strength to suppress the energy spread, and finally it becomes no solution to obtain the minimum energy spread. Another method to compensate the longitudinal wakefield is the bunch flip. The longitudinal wakefield after the bunch flip can compensate the longitudinal wakefield before the bunch flip as shown in Fig. 5.

The second switch yard (SY2) is the best point to realize this method because it places the middle of the straight part from C-sector to 5-sector. However the chicane is hard to obtain the negative R_{56} which is required

to flip the bunch. The six quadrupole magnets are required to obtain the negative R_{56} in the chicane, and it is very hard to place because of the interference to the another positron or straight beam line. Figure 6 shows another way to obtain the negative R_{56} . In this way, the dispersion generation and reduction are required before and after this chicane. The betatron oscillation induced by a single kick can make the dispersion generation and reduction. This causes the horizontal emittance dilution, however, the horizontal emittance acceptance for SuperKEKB injection is much larger than the vertical one.

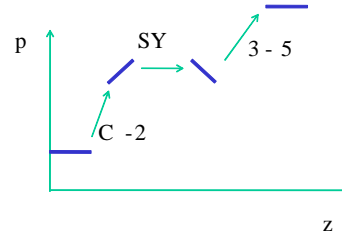

Figure 5: Longitudinal wakefield cancellation.

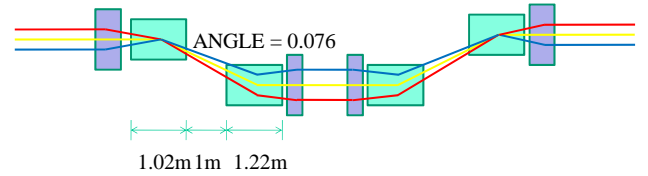

Figure 6: Bunch flip at SY2.

LONGITUDINAL BUNCH MEASUREMENT

We are using the streak camera with the resolution of 2 ps to measure the bunch length. Also we are preparing to install the X-band RF deflector at the third switch yard (SY3). Further we are planning to install the temporal magnification system (same as spectral decoding system) using the EO sampling.

SUMMARY

The temporal manipulation is effective to reduce both the transverse emittance dilution and the energy spread. We aim to realize the temporal manipulation using the wideband laser system and the double bunch compression at the chicane at the low energy region and the J-ARC section. Further the bunch flip is optionally required in case of the larger alignment error.

REFERENCES

- [1] T. Natsui et al., "Quasi Traveling Wave Side Couple RF Gun for SuperKEKB", TUOCB103, IPAC13, Shanghai, China, proceedings of this conference.
- [2] X.Zhou, et al., "Ytterbium Laser Development of DAW RF Gun for SuperKEKB", WEPME018, IPAC13, Shanghai, China, proceedings of this conference.