

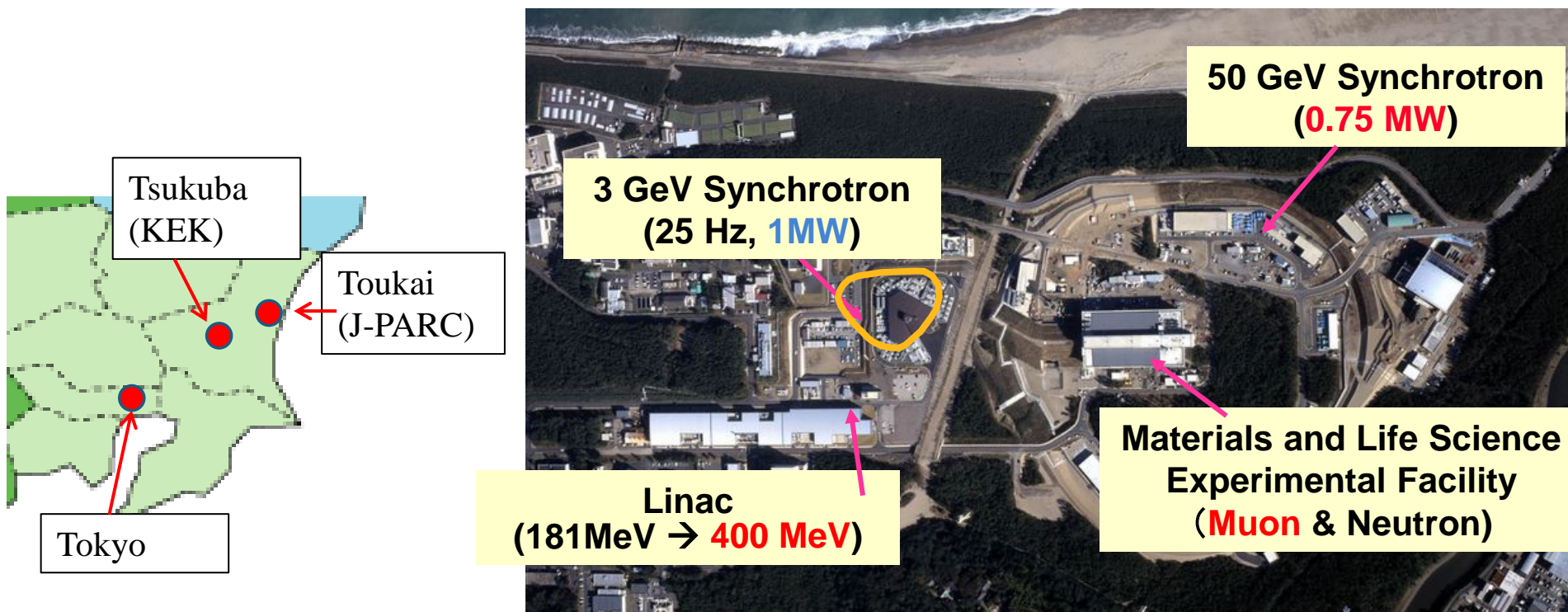

August 7th, 2015@福井・あいあいプラザ
第12回日本加速器学会年会

J-PARC/MUSEにおけるミュオン回転標的の現状



J-PARC Center, MLF Division, Muon Section (KEK-IMSS)
Shunsuke Makimura (shunsuke.makimura@kek.jp)

J-PARC/MLF/MUSE & MUON TARGET

MUon Science Establishment (MUSE)

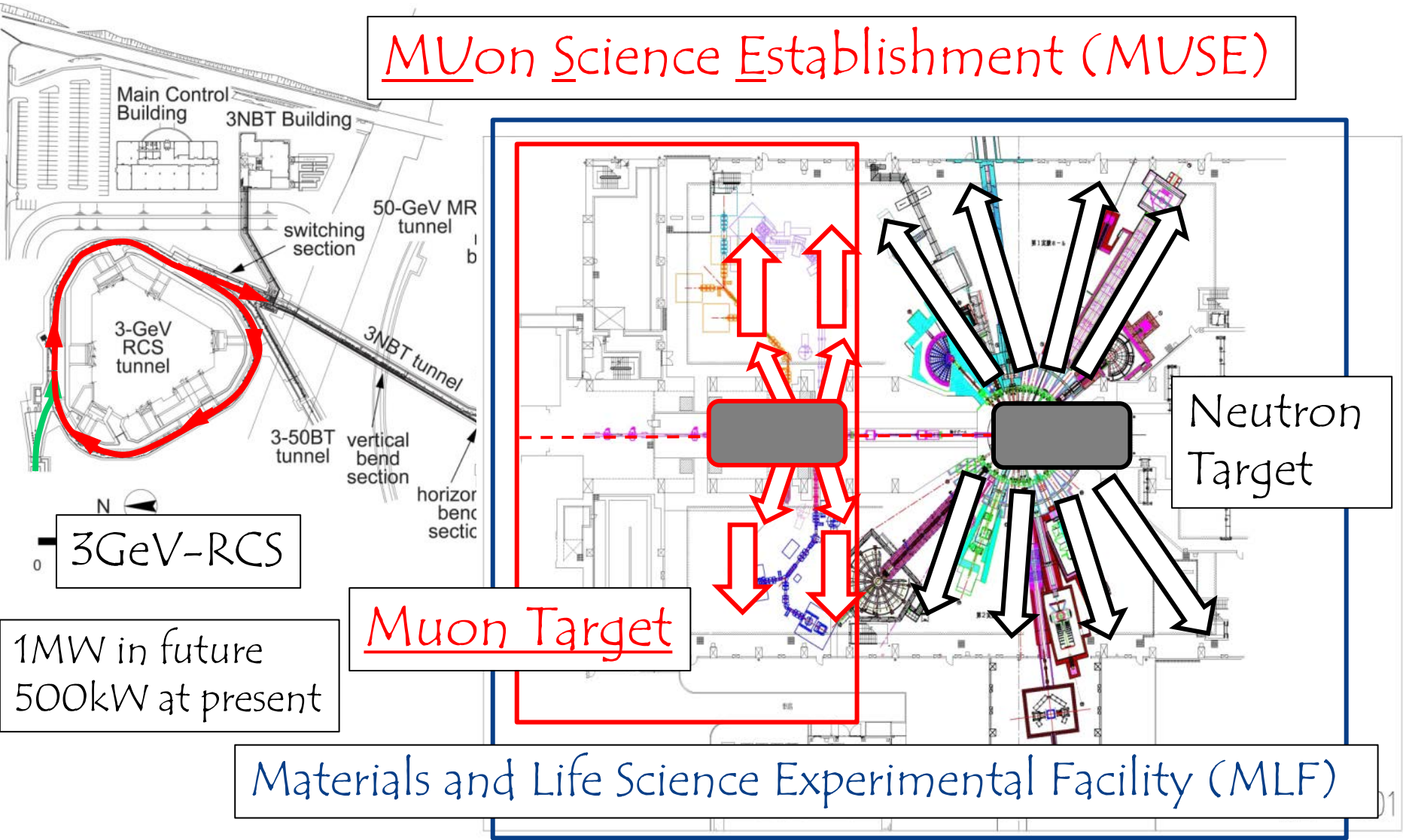

3GeV-RCS

1MW in future
500kW at present

Muon Target

Neutron Target

Materials and Life Science Experimental Facility (MLF)

The most intense pulsed muon beam all over the world

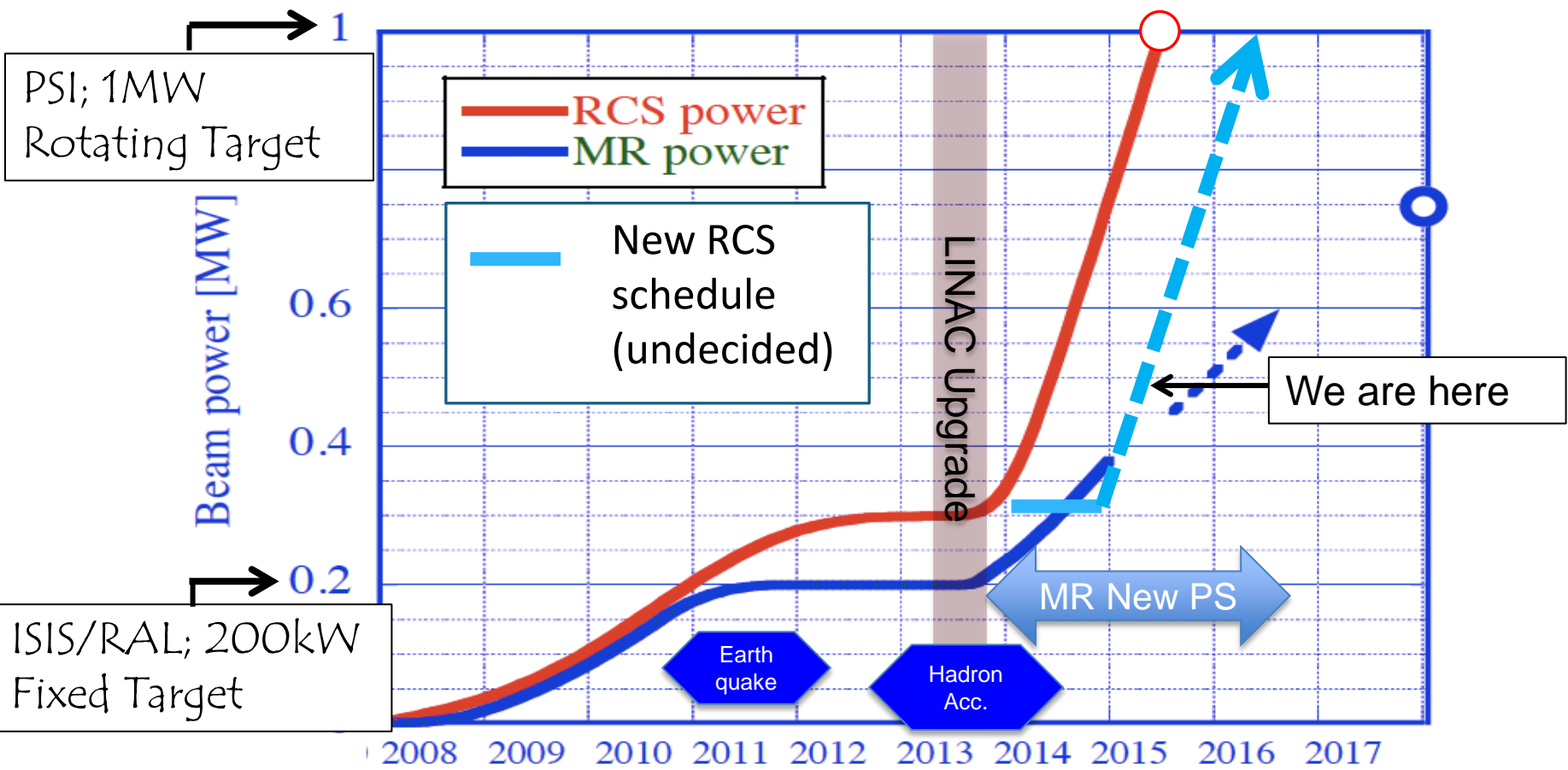

Country	Japan	U.K.	Switzerland
Facility	J-PARC MUSE	RAL ISIS	PSI

2014年9月に固定標的方式から回転標的方式に交換を行った。

DC / Pulse	Pulse (25Hz)	Pulse (50Hz)	DC
------------	--------------	--------------	----

Muon Fixed Target (Graphite)

Isotropic Graphite
IG-430V (Toyo Tanso)
Diameter; 70mm
Thickness; 20mm

P-Beam diameter; 16 mm (2σ)
4kW heat @ 1MW proton beam

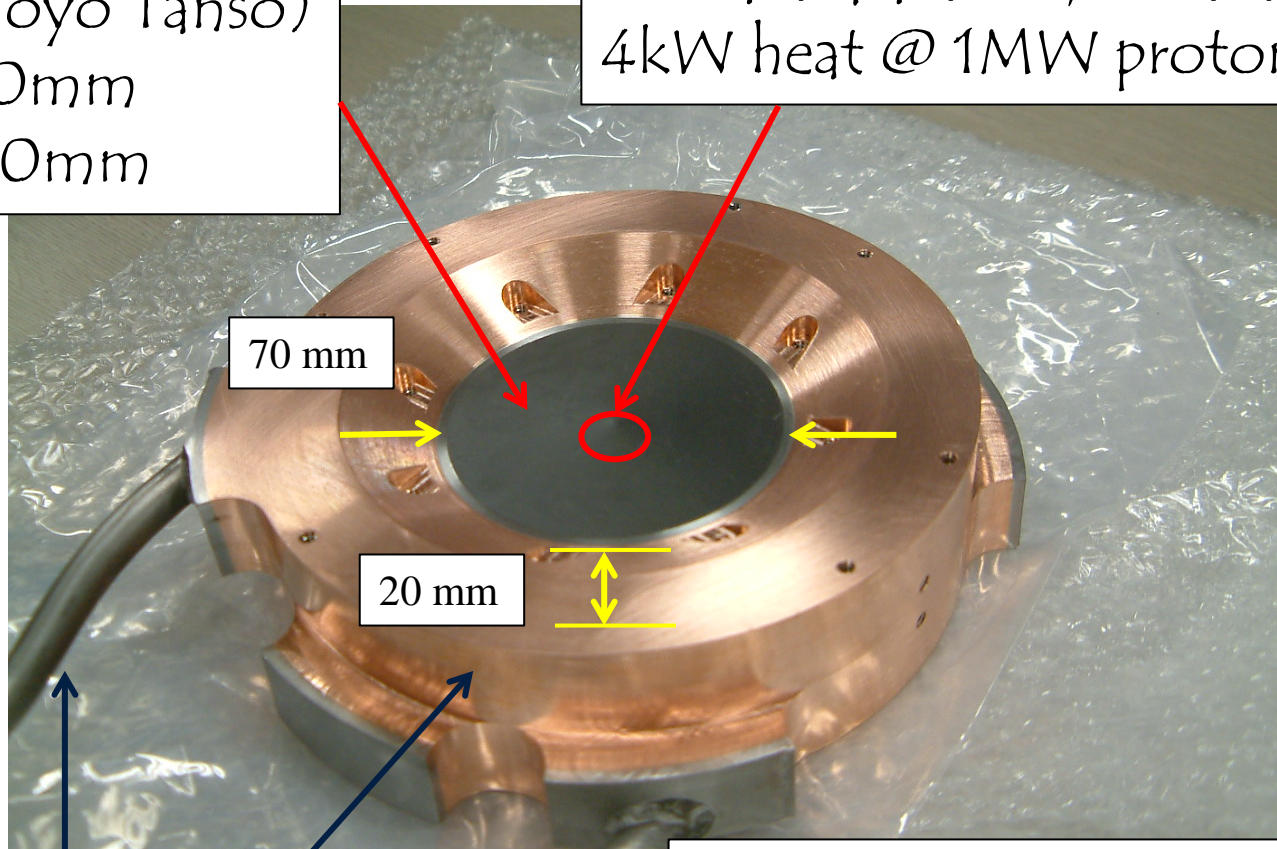

Stainless steel pipe (Water)
Copper frame
Hot Iso-static Press method

Stable proton beam operation
without replacements for 5 years
(ISIS/RAL; Beam Power 200kW,
3 ladder-targets ~Lifetime; 1 year)

Lifetime & Replacement of Muon Target

- ❑ Radiation damage of graphite; Dimensional change Lifetime; < 1year @1MW beam operation
- ❑ Replacement by remote handling

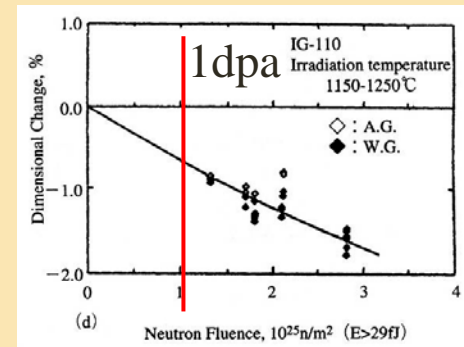

Journal of Nuclear Materials 195(1992)44-50.
graphite1991 [No.150] 290-302

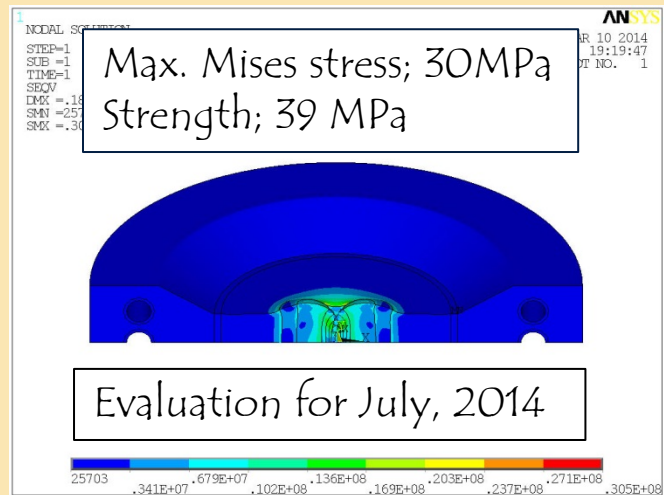

Beam spot will shrink by proton irradiation.

Rotating Target

Learning from Paul Scherrer Institute, Rotating target method is applied to distribute the irradiation damage of graphite to a wider area.

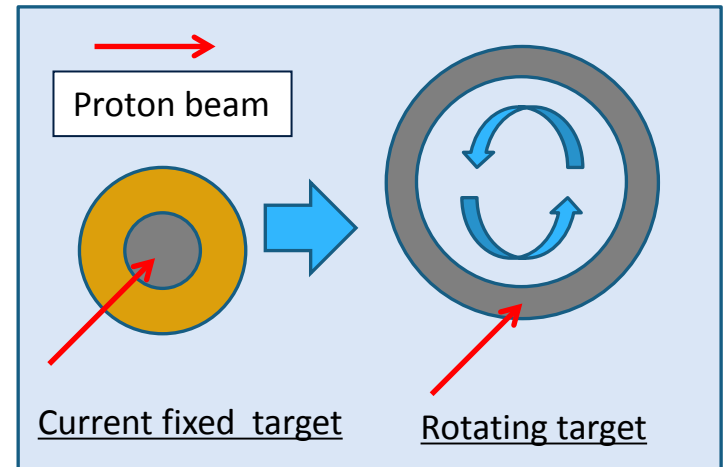

The lifetime of graphite becomes long enough.
The lifetime of bearings is critical.
Solid lubricant;

- ❑ Silver coating with MoS₂ at PSI
- ❑ Disulfide tungsten at MUSE

Expected lifetime; 10 years

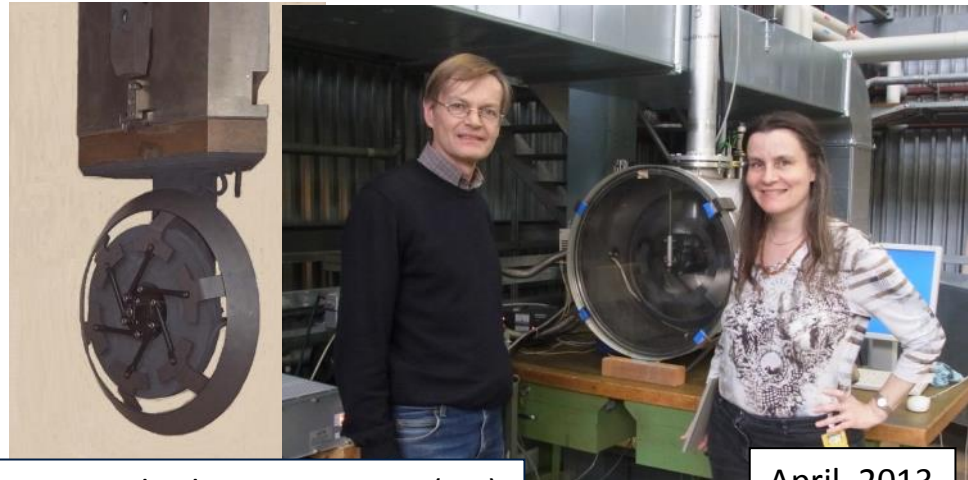

E target at Paul Scherrer Institute (PSI)
Lifetime; less than 1 year

April, 2013

Collaboration with PSI Target group since 2004

Bearing & Solid lubricants

For our target, the bearing is used under 100 MGy/year, 400 Kelvins, 10^{-5} Pa

	Type	Temp. (Kelvins)	Pressure (Pa)	Radiation	Speed (rpm)	Storage	Lifetime @15rpm (hour)
MoS ₂	<u>coating</u>	<570	10 ⁵ to 10 ⁻⁵	<u>general</u>	<500	<u>air</u>	<u>1100</u>
Ag	<u>coating</u>	<600	10 ⁻³ to 10 ⁻¹⁰	<u>general</u>	<500	<u>vacuum</u>	<u>5800</u>
WS ₂	<u>Separator</u>	<600	10 ⁵ to 10 ⁻⁵	<u>few</u>	<210	<u>air</u>	<u>110000</u>



Retainer, balls, & rings, coated by MoS₂ or Silver



Separator made of sintered compact of WS₂

Great amount of Lubricant

Captured from JTEKT(KOYO) Catalog

Evaluation by the formula of the JTEKT Catalog



Disulfide Tungsten is used for MUSE target.

Anticipated Lifetime is 20 years!!

Radiation resistance of WS₂ should be confirmed.

Radiation Resistance of WS₂

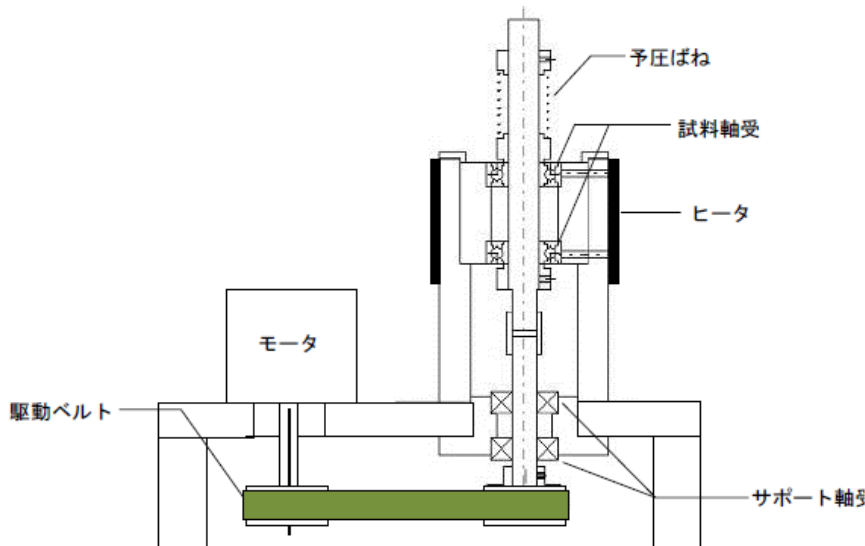
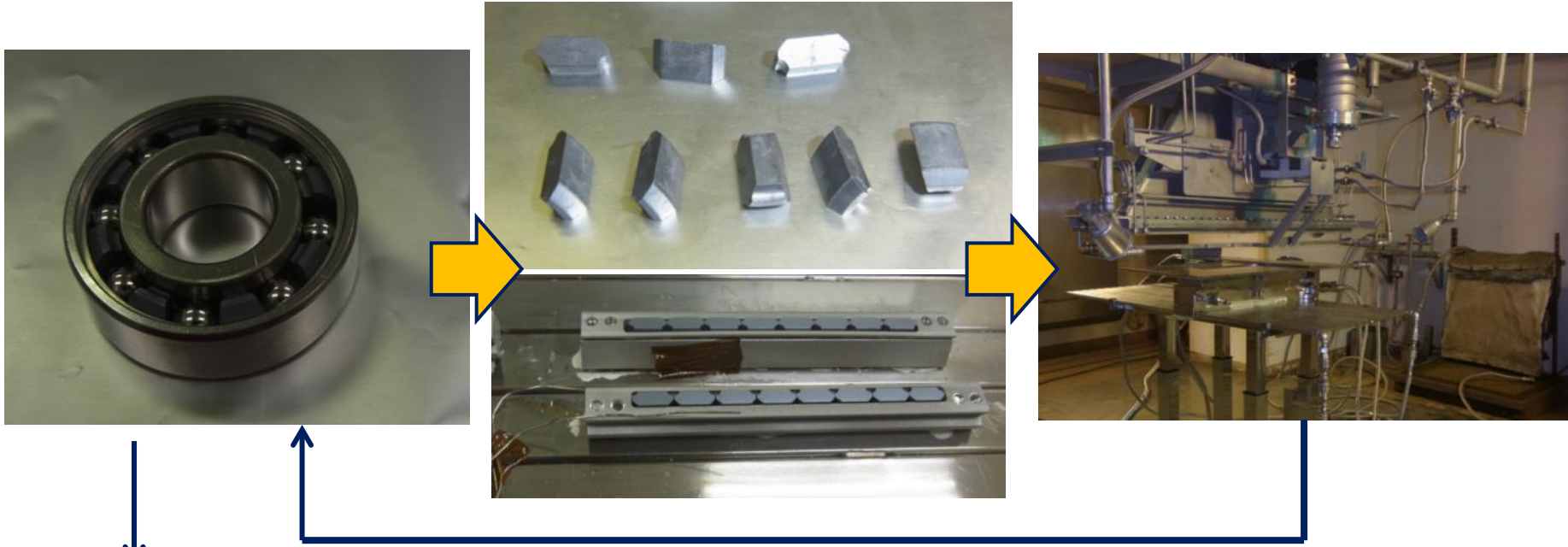

Electron beam irradiation
JAEA, Takasaki,
2MV, 1mA, 20hours, 100MGy
Durability tests with load & heat
4.5 million revolutions,
1year@ beam line
No irradiation effect was observed.

Mock-up of Rotating Target

Durability tests of
Target & bearings
Heating & Rotating tests

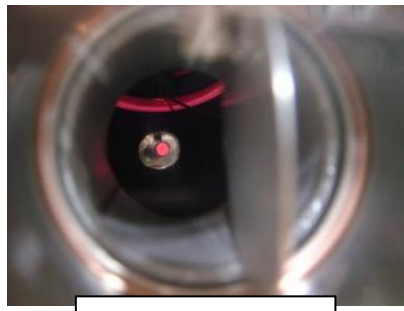
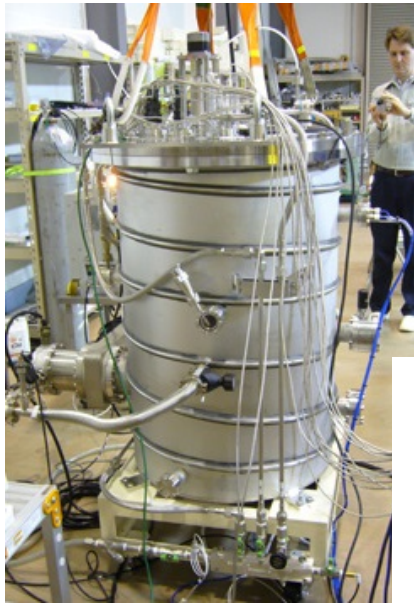

Heating test

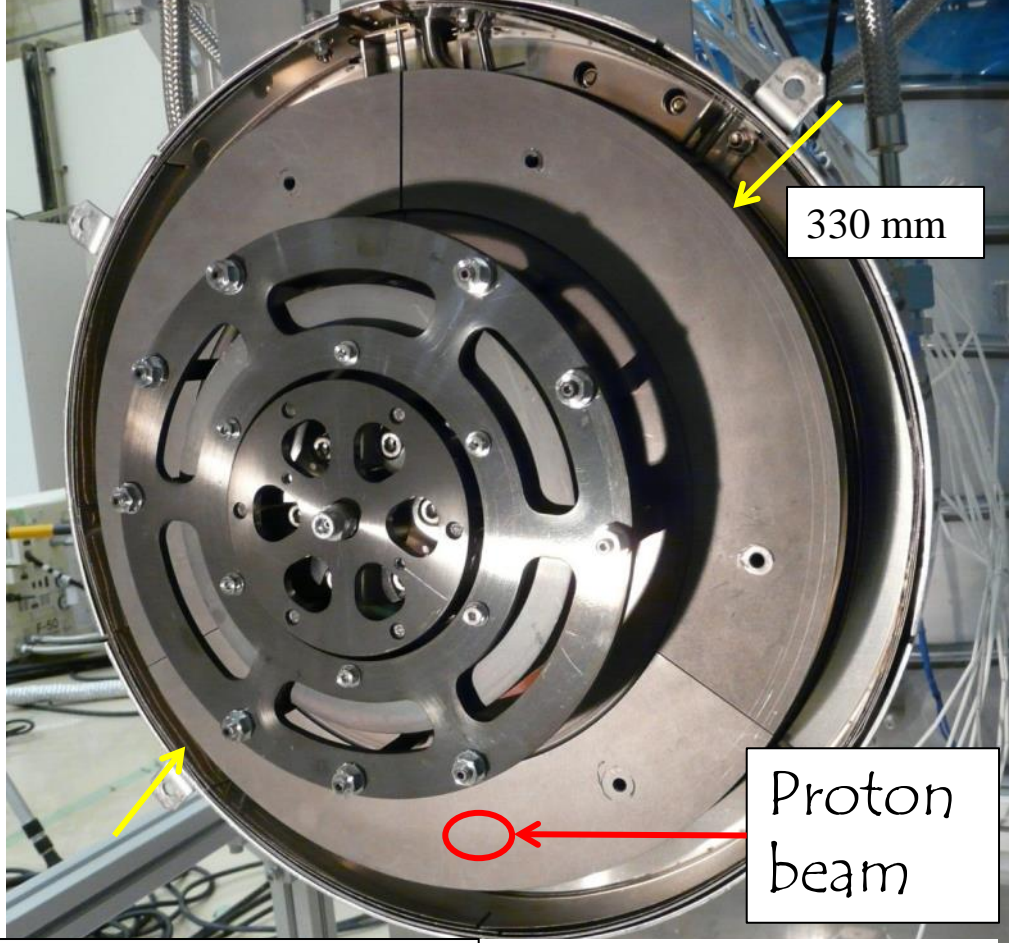

330 mm

Proton beam

Motor torque (x 10 %)

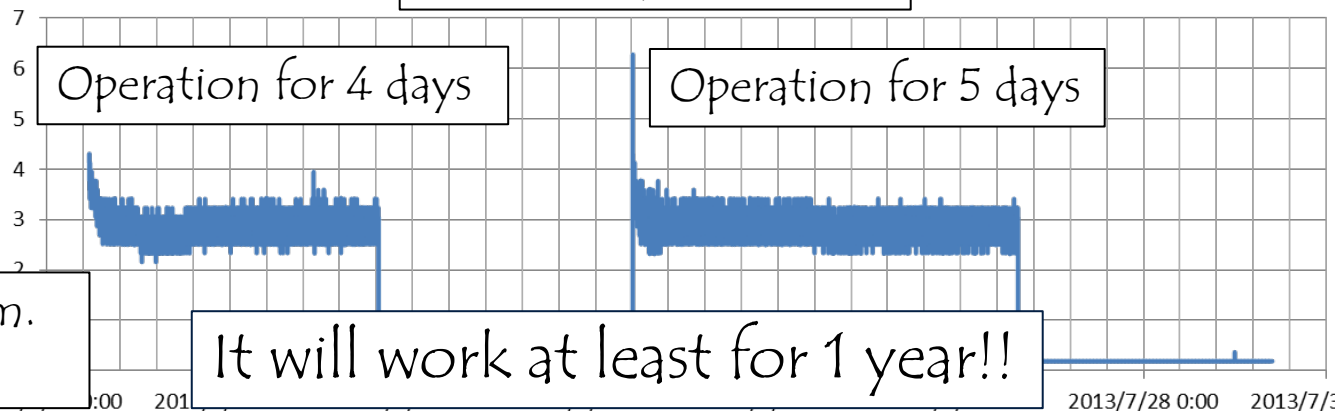

9 days with 300 r.p.m.
(4800h @15 r.p.m.)

It will work at least for 1 year!!

2013/7/28 0:00 2013/7/30 0:00

Replacement of the used Fixed target

30th July, 2014

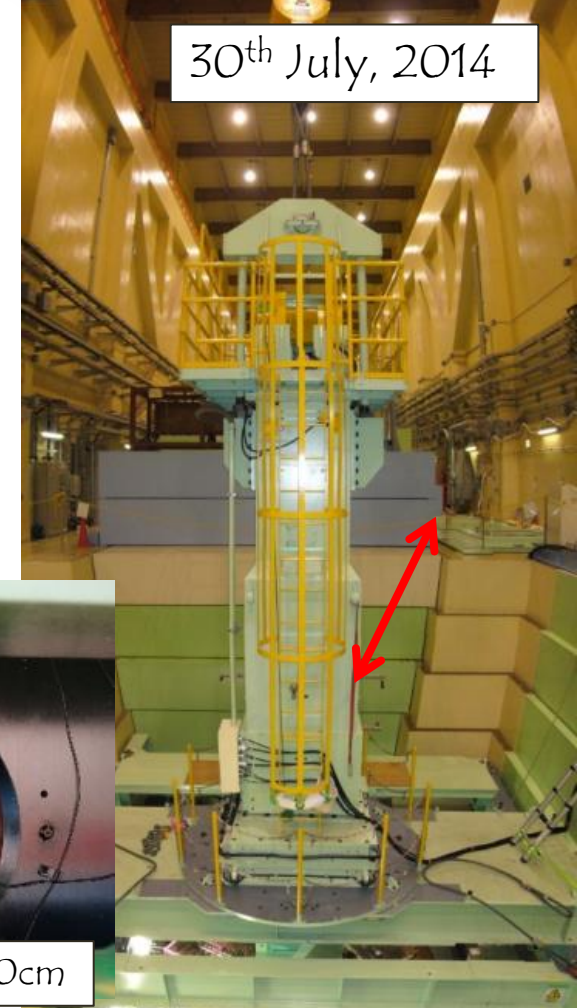
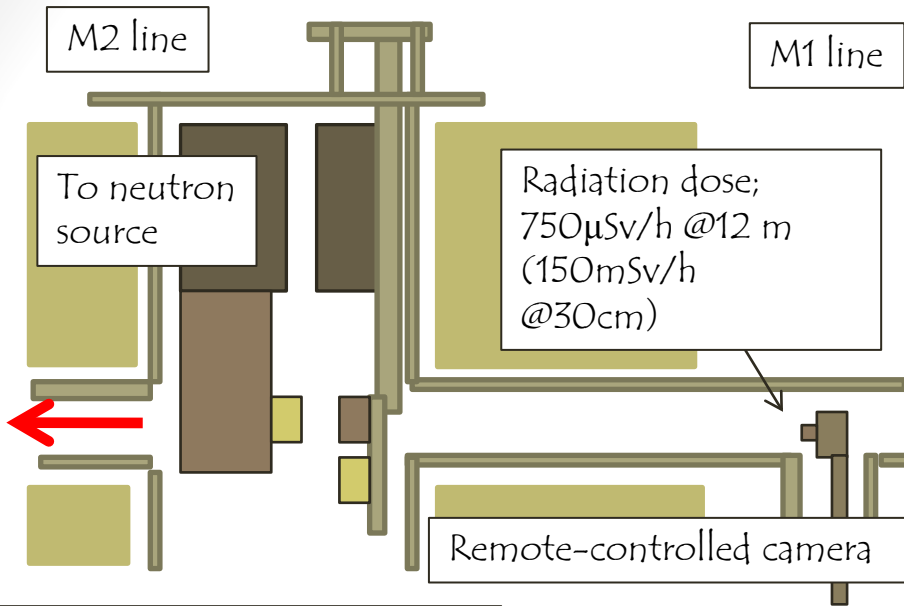

No crack was observed.

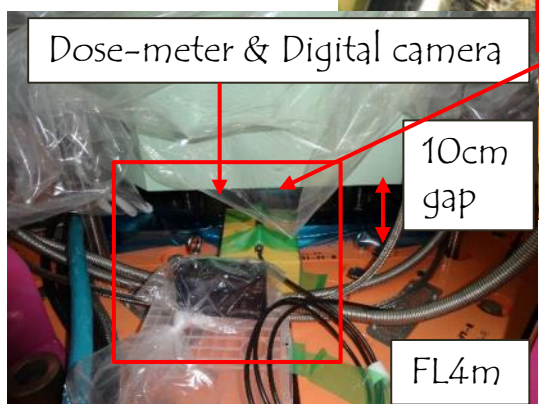
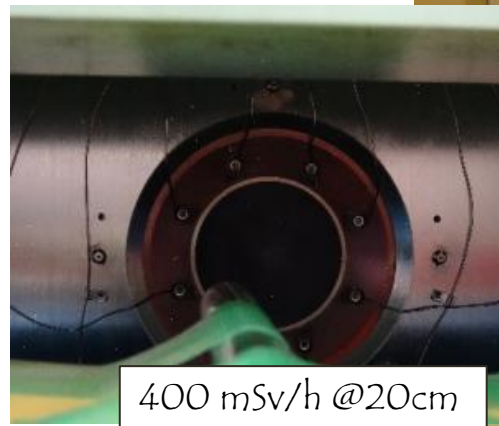

Transportation to tentative storage vessel

7th July, 2014

Installation of Rotating Target

Rotating Target was successfully installed on 16th September of 2014.

- ❑ Vacuum pressure; 10^{-5} Pa
- ❑ Control system; Confirmed

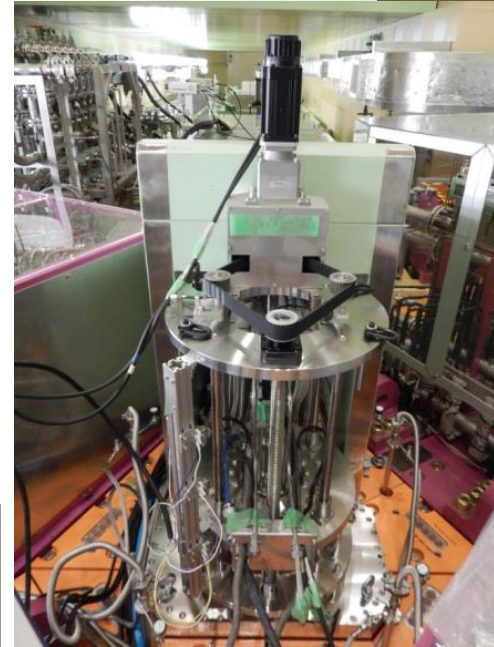

Operation of muon rotating target

300-kW & 400-kW operation for 3 months
 600-kW operations for 1 hour on 8th Apr./2015
 500-kW operation for 1 week

Motor torque has been remaining constant.

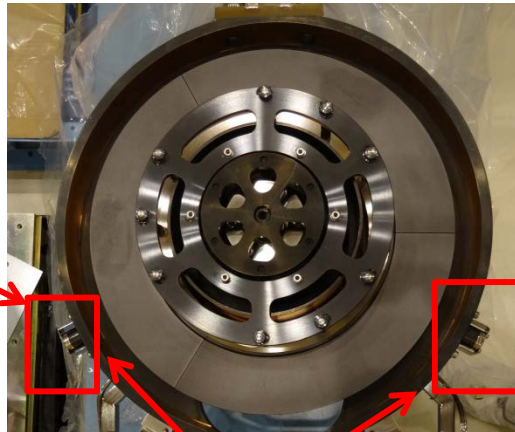
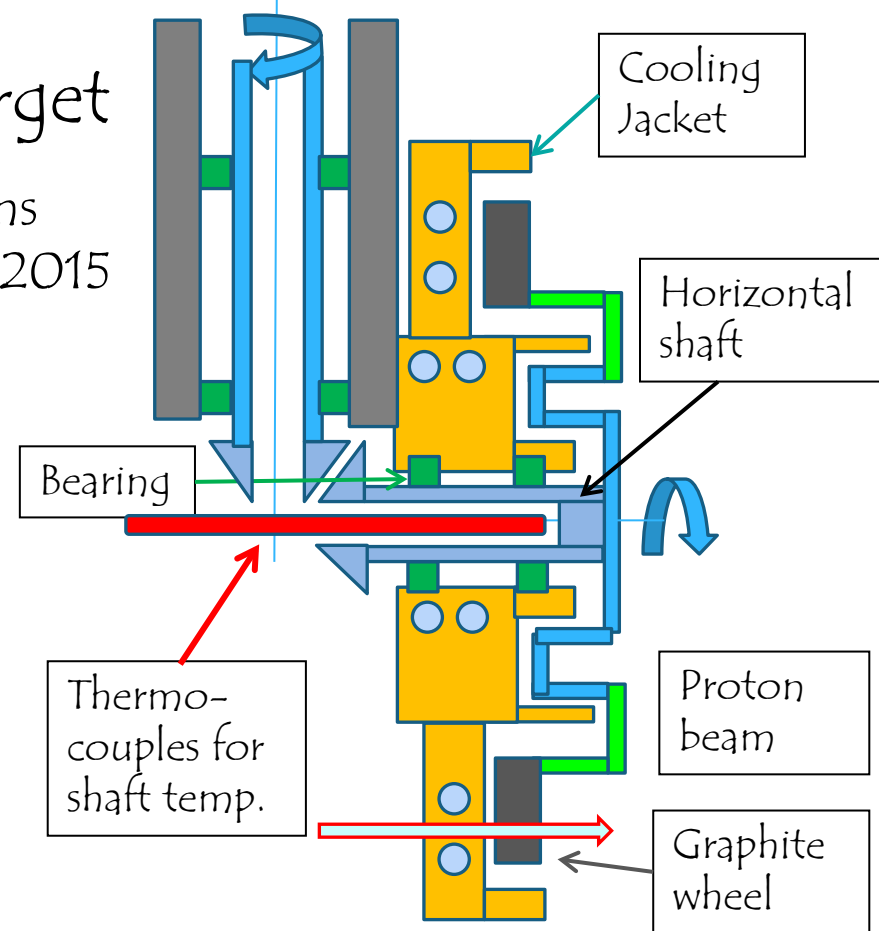

試験運用中

Graphite temperature by thermal radiation

	300kW	500kW	1MW
Shaft (Simulation)	71 degC	84 degC	112 degC
Shaft (Measurement)	78 degC	95 degC	-
Graphite (Simulation)	400 degC	475 degC	620 degC
Th. radiation (Measurement)	45 degC	60 degC	-

Summary

- Since 2008, Stable beam operation by Graphite Fixed target.
- Graphite Rotating Target was installed last September.
- Stable proton beam operation by Graphite Rotating target

ACKNOWLEDGMENT

- 回轉標的加熱回轉試験機；日立造船
- 回轉標的実機；入江工研
- 軸受；JTEKT
- 潤滑材の電子線照射試験；大島氏、花屋氏（原研高崎）

Thank you for your attention