

# DESIGN OF A COMBINED-FUNCTION QUADRUPOLE-SEXTUPOLE MAGNET FOR HISOR-II

Y. Lu\*<sup>1,3</sup>, M. Katoh<sup>1,2</sup>, M. Shimada<sup>3,1</sup>, H. Miyauchi<sup>3,1</sup>,

<sup>1</sup>Hiroshima Synchrotron Radiation Center, Hiroshima University, Higashi-Hiroshima

<sup>2</sup>UVSOR Synchrotron Facility, Okazaki

<sup>3</sup>High Energy Accelerator Research Organization (KEK), Tsukuba

## Abstract

HiSOR-II is a low-energy storage ring and is under designing for the future plan at Hiroshima Synchrotron Radiation Center. A compact lattice is desired to reduce the cost and space, which requires combined-function magnet components. In this paper, a combined-function quadrupole-sextupole magnet for the beam focusing and chromaticity correction is introduced. We proposed two different designs using auxiliary coil and pole profile adjustment, respectively. The magnet field is calculated using Poisson and Radia. Both designs have been optimized to meet the magnetic field requirement.

## INTRODUCTION

HiSOR is a small synchrotron light source operated from 1996 in Hiroshima University [1]. A new low-energy storage ring HiSOR-II is under designing for the increasing demand of high-brilliance radiation. A proposed ring lattice layout is shown in Fig. 1, which only consists of two kinds of magnet. The bending magnet and quadrupole magnet are both combined-function magnets. The bending magnet is capable of producing quadrupole and sextupole field, and the quadrupole magnet is capable of producing sextupole field. The use of combined-function magnet is to reduce the operation cost, the accelerator size and the amount of materials for the lattice components. The major parameters of the ring are summarized in Table 1.

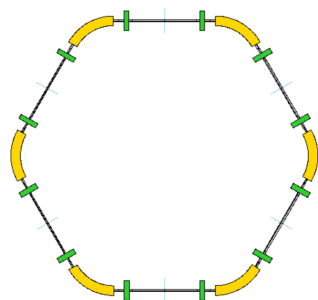

Figure 1: Layout of HiSOR-II ring.

The design of the quadrupole magnet is reported. We proposed two different designs using auxiliary coil and pole profile adjustment, respectively. From the ring lattice, the length of the magnet is 0.18 m. The quadrupole field is 7.55 T/m, and the sextupole field is 15.20 T/m<sup>2</sup>. Due to the

Table 1: Parameters of the Proposed Lattice

Major Parameters	Proposed Design
Energy [MeV]	500
Circumference [m]	31.38
Emittance [nm]	17.73
Beam current [mA]	300
RF frequency [MHz]	191
Tune ( $\nu_x, \nu_y$ )	2.75/2.46
Number of undulators	4

low energy of the ring, the strengths of the multipole components are relatively small. In addition, the sextupole strength can be minimised if they are positioned in the quadrupole magnet where the beta-functions are large.

## DESIGN USING AUXILIARY COIL

The basic idea is to use two auxiliary coils to generate sextupole component in a quadrupole magnet [2]. The radius of the magnet aperture is assumed to be 40 mm.

### Preliminary design of a quadrupole magnet

Firstly, a quadrupole magnet is designed using Poisson. A  $\frac{1}{8}$  model of the quadrupole magnet is shown in Fig. 2. The total current of the coil  $NI$  is approximately given by

$$NI = \frac{kr^2}{2\mu_0}, \quad (1)$$

where  $k$  is the gradient of the magnetic field,  $r$  is the aperture radius, and  $\mu_0$  is the magnetic permeability in vacuum.

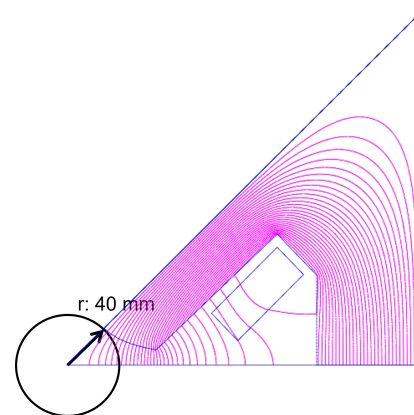

Figure 2: 1/8 model of the quadrupole magnet.

\* yaolu@hiroshima-u.ac.jp

### Combined-function magnet using auxiliary coil

Once the geometry of the quadrupole magnet and the current value are decided, two auxiliary coils are added. The sextupole magnetic field is generated by a sextupole coil and a dipole correction coil. As shown in Fig. 3 (a), the quadrupole field is generated by the quadrupole coil (red). Figure 3 (b) shows the magnetic field generated by the sextupole coil (brown) and the dipole correction coil (green). The currents of the sextupole coil and the dipole correction coil are adjusted to produce a desirable sextupole field and remove the dipole field at the center. The current densities of both the sextupole coil and dipole correction coil are 4 A/mm<sup>2</sup> and 0.35 A/mm<sup>2</sup>, respectively.

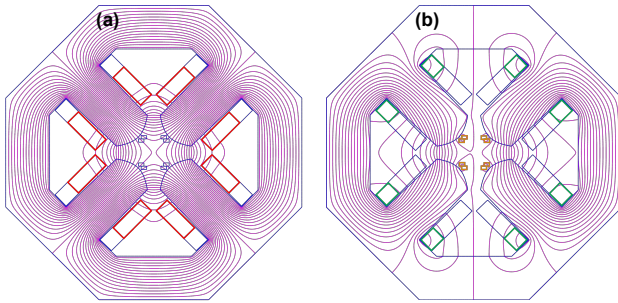

Figure 3: (a) Magnetic field generated by the quadrupole coil. (b) Magnetic field generated by the sextupole and dipole correction coil.

Then a 3D model magnet is simulated in Radia [3], which is shown in Fig. 4. The Radia can provide a 3D data of magnetic field which will be used for a particle tracking in the future. The horizontal distributions of  $B_y$  calculated by Poisson and Radia are shown in Fig. 5. The result of Radia is well consistent with the result of Poisson. A parabolic distribution appears after removing the quadrupole component, which indicates the remaining magnetic field is from a sextupole component.

In the design, the harmonic analysis gives the strength of multipole components, which is more accurate than extracting the polynomial coefficients from the curve fitting of the  $B_y$  distribution in Fig. 5.

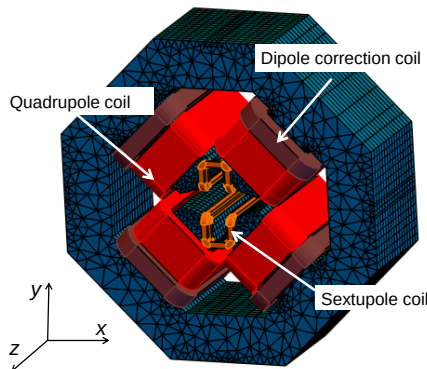

Figure 4: Combined-function magnet using auxiliary coil in Radia.

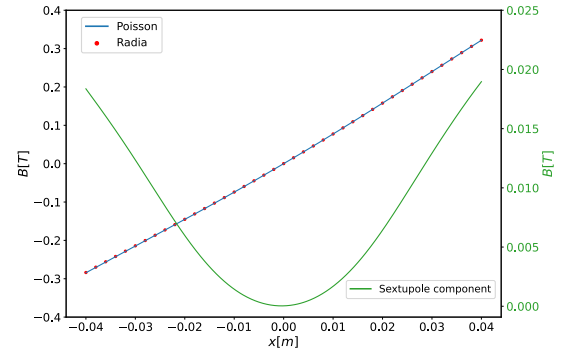

Figure 5: Horizontal distributions of  $B_y$  at the magnet center.

### Magnetic saturation

The magnetic saturation is also evaluated in the simulation. If the magnet is saturated, there will be a risk that the dipole field cannot be eliminated. Because the magnetomotive force is mainly generated by the quadrupole coil, for simplicity, the current is only supplied in the quadrupole coil in the simulation. Figure 6 shows the magnetic field gradient changing with the current. The total operation current of the quadrupole coil is around 5000 A. Therefore, magnetic saturation will not occur in the magnet operation.

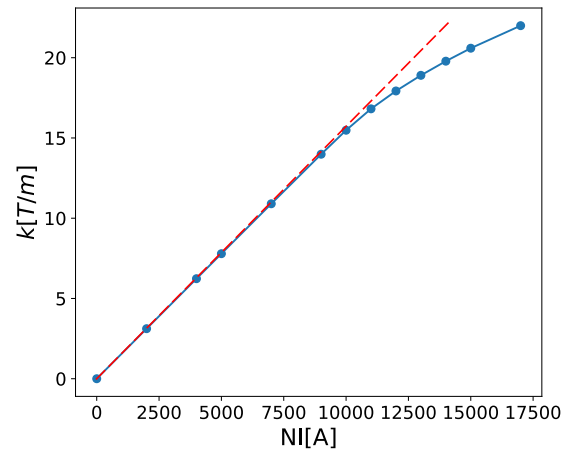

Figure 6: Magnetic field gradient changing with the current.

### DESIGN USING POLE PROFILE ADJUSTMENT

The other method is to adjust the pole profile to generate a quadrupole and sextupole magnetic field directly [4].

#### Basic method

The magnetic field expression of a normal magnet in 2D case is given by

$$B_y + iB_x = \sum_{n=0}^{\infty} c_n (x + iy)^n, \quad (2)$$

where  $c_n$  is called  $2(n+1)$ th multipole coefficients [5]. Then a function of scalar potential can be found. Because the pole face is an equipotential surface. The pole profile is a superimposition of the quadrupole field and sextupole field potentials, which satisfies

$$\varphi = -(kxy + s(x^2y - y^3/3)) \quad (3)$$

Therefore, the pole profiles can be found for a given quadrupole field  $k$ , sextupole field  $s$ , and magnet aperture. As shown in Fig. 7, the pole profile of the combined-function magnet is compared with a pole profile of a quadrupole magnet.

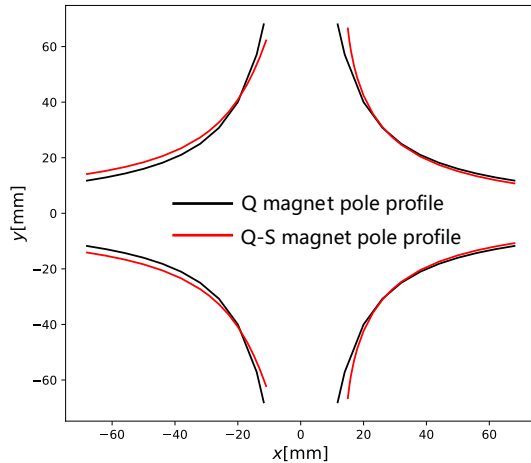

Figure 7: Pole faces of quadrupole magnet and quadrupole-sextupole magnet.

### Optimization of the pole profile

The pole profile in Fig. 7 was used as a first approximation. The  $k/s$  ratio simulated in Poisson/Radia is in good agreement with the designed value but still has a small discrepancy. The shimming of the pole face should be performed to get proper quadrupole and sextupole components and decrease another multipole components. After the shimming, the magnet model constructed in Radia is shown in Fig. 8.

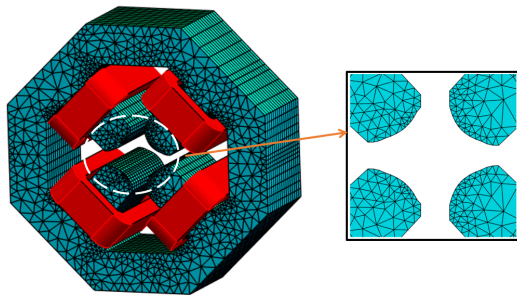

Figure 8: Combined-function Magnet using Pole profile adjustment in Radia.

The multipole components are extracted at  $r = 10$  mm. As shown in Fig. 9, multipole components reduced a lot after the shimming.

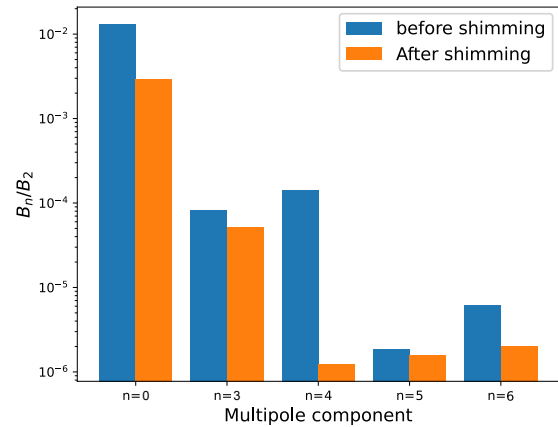

Figure 9: Multipole components optimization by shimming.

It should be noted that the end effect is not considered in the current work, which may change the  $k/s$  ratio and also enlarge higher multipole components. A chamfer at the end of the pole end will be applied for a further optimization later.

## CONCLUSION AND PROSPECTS

Two potential designs of the combined-function quadrupole-sextupole magnet are introduced. The magnet using auxiliary coil has a complicated structure. Three independent power sources should be prepared. The current density of the sextupole coil is relatively high, which indicates the sextupole coil should be water-cooling. The advantage is that the quadrupole and sextupole magnetic field can be adjusted separately. As for the magnet using pole profile adjustment, it has a simple structure. However, the quadrupole and sextupole magnet field cannot be adjusted separately.

To save energy and get rid of water-cooling system, we are considering using permanent magnet material to generate the magnetomotive force. The coil will be kept for a magnetic field adjustment. The design of vacuum chamber will be conducted later.

## REFERENCES

- [1] K. Yoshida *et al.*, "Compact Synchrotron Light Source of the HSRC", *J. Synch. Rad.* (1998). 5, 345-347.
- [2] J. Yamazaki *et al.*, "Lattice Components for Upgrading UVSOR", in *13th Symposium on Accelerator Science and Technology*, Suita, Osaka, Japan, October 2001.
- [3] RADIA, <https://www.esrf.fr/Accelerators/Groups/InsertionDevices/Software/Radia>
- [4] Design Report for the MAX II Ring, September 1991.
- [5] S. Y. Lee, "Accelerator Physics", 2nd Edition, World Scientific, Hackensack, N.J., 2004.