

Installation and measurement of the ATF Injection Kicker

T. Naito, T.Korhonen, K. Kubo, N. Terunuma, J.Urakawa,
 A.R.Donaldson*, D.S.Williams*, P.Blum*, B.McKee*,
 KEK,High Energy Accelerator Organization, 1-1 Oho Tsukuba, Ibaraki, Japan 305
 *Stanford Linear Accelerator Center, Stanford, CA 94309, USA

Abstract

An injection kicker system of the same type as SLC North Damping Ring(NDR, for e- injection) is used at ATF DR for future linear collider development in KEK. The magnet and the power supply have been constructed at SLAC and installed to the ATF DR at June 1996. The system has been operated from the beginning of commissioning, January 1997, to the present operation, July 1997, with single bunch injection mode. The construction and the operation has been done as a part of the collaboration program of the ATF project. The operation characteristics of the injection kicker were measured using beam. The system configuration and the result are described in this paper.

1 INTRODUCTION

ATF DR in KEK aims to make a small emittance beam to obtain a high luminosity for future linear collider. ATF was designed to circulate multi-bunch beam, 20 bunches with 2.8ns spacing, and multi-train of max. 5 trains¹⁾. The injection kicker magnet is required to produce a pulse magnetic field which has very fast rise and fall time with 60ns flattop. The parameters shown in Table 1, are almost the same as SLC NDR of SLAC. We agreed to use the same type of the kicker system as a part

of the collaboration program. The SLAC kicker system has a long improvement history²⁾³⁾⁴⁾. Especially, they spent large effort for the magnet to improve the pulse shape and the higher voltage capability⁵⁾. Thus the system is expected to have high reliability and good pulse characteristics for ATF application.

The components of the kicker system were manufactured and tested at SLAC. The system was assembled and installed into ATF DR at June 1996. The pulse characteristics were measured and confirmed the performance except for the pulse flatness. The system has been working from the commissioning to the present without serious problem. The operation parameters were; energy: 0.95GeV(Jan~April) and 1.3GeV(May~July), Intensity: 3~6x10⁹(single bunch), repetition rate:0.8 or 1.5 Hz. The operation characteristics of the kicker were measured by using the beam.

	ATF DR	SLC NDR
Energy	1.5GeV	1.2GeV
Kick angle	5mrad	8mrad
magnet length	45cm	45cm
magnetic field	510Gauss	710Gauss
rise time	60ns	60ns
fall time	60ns	60ns
flat top	60ns	60ns

Table 1 Specification of the ATF/SLC injection kicker

2 SYSTEM DESCRIPTION AND INSTALLATION CHARACTERISTICS

The schematic drawing of the kicker pulser is shown in Fig.1 and the installed kicker magnet is shown in Fig.2. The high voltage charges to two shorted pulse forming lines. The charging starts about 100μsec before the thyratrons are discharged. It is called command charging and can hold the stable charging voltage for different repetition rate. Two thyratrons(CX1671D) discharge at the same timing and the current is transferred to 12.5 ohm load termination through the kicker magnet. The magnet is required to have a matched impedance for high frequency region. The specifications are; charging voltage(max.): 80kV(the high voltage at the magnet correspond to the half of the charging voltage), current(max.): 3200A(produce 948 Gauss at the magnet), pulse width: 130ns(FWHM) and impedance: 12.5 ohm.

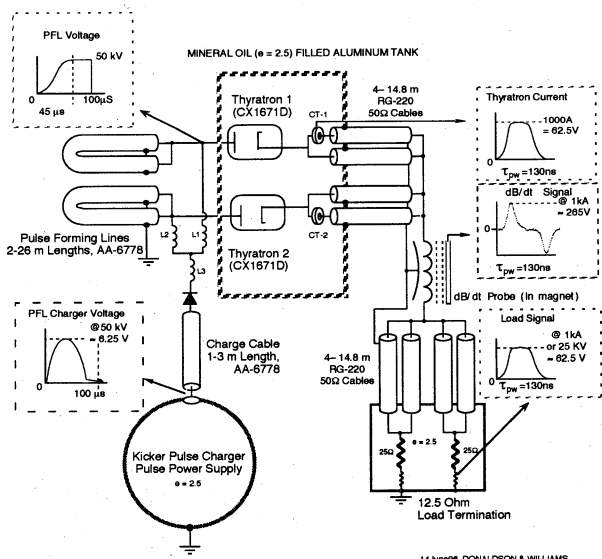

Fig.1 Simplified Schematic drawing of the kicker system

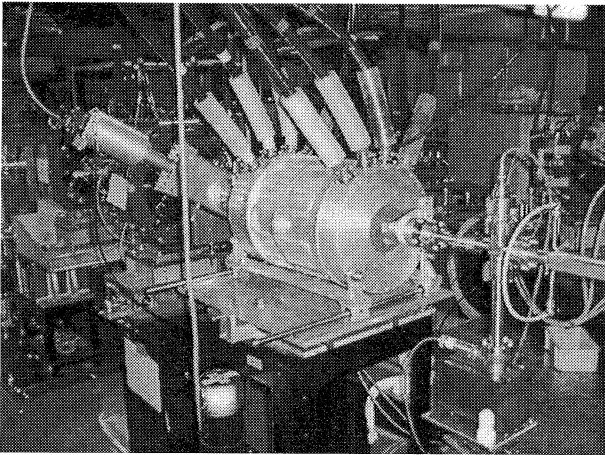

Fig. 2 Installed kicker magnet at ATF

The kicker system was successfully installed and connected to the trigger and control system. The magnet was mounted on its own support and the beam line chamber was pumped down to 5×10^{-8} Torr. The magnet was processed, by watching the vacuum level, up to 48kV charging voltage and at the repetition rate of 1Hz, 25Hz, 50Hz and 60Hz. There were no signs of arcing or the odor of ozone. The pulse characteristics were measured after the processing. Fig. 3 shows the wave shape of the current of the two thyratrons. About 10% of reflection was observed. The reflection is affected to the multi-train injection. The spacing of the trains at the case of 5 train is only 39.2ns. The calculated impedance from the voltage wave shape and the current wave shape was 13.7

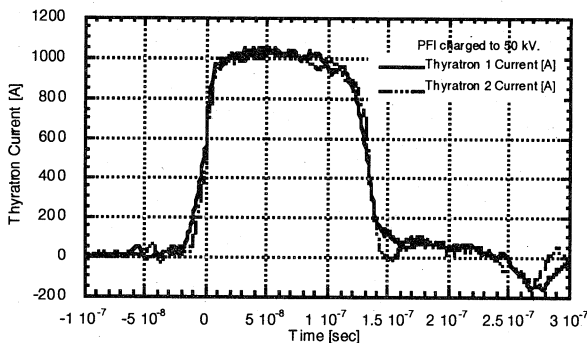

Fig.3 pulse shape of the thyatron currents

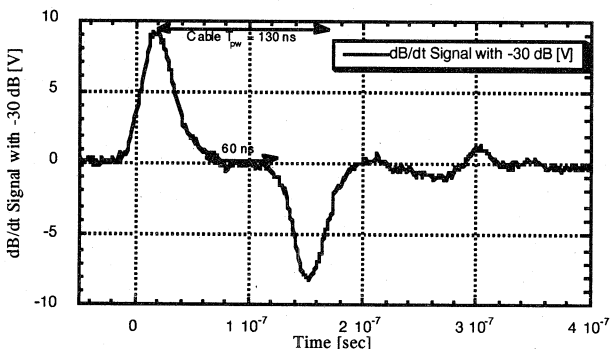

Fig.4 pulse shape of the dB/dt pick up

ohm. The reflection rate was agreed with the impedance mismatch. However, the DC resistances were measured as 12.7 ohm and 12.2 ohm, respectively. Fig. 4 shows dB/dt pick up coil signal which is proportional to the time derivative of the magnet field. The amplitude jitter of the charger voltage was 0.33%(peak to peak) which was limited by the resolution of the instrumentation.

3 KICK ANGLE MEASUREMENT WITH BEAM

The kick angle of the beam was measured from the injection orbit and the first turn orbit by changing the high voltage, the timing and the repetition rate. This measurement was affected by the orbit error and the beam loss come from the small physical aperture of the beam path. The estimation was done by #22BPM signal located at 1.076m downstream of the kicker and the R12 and the R34 transfer matrices. The resolution of the BPM was $\sim 100\mu\text{m}$. The measurement was done with following two conditions, the energy: 0.95GeV and 1.3GeV.

3.1 High voltage characteristics

The absolute kick angle couldn't be measured directly, because the orbit couldn't be measured at zero voltage setting. The differences of the kick angles at the different high voltage settings from 16kV to 27kV were measured. The absolute kick angle was estimated by subtracting the offset of the zero cross of the linear fitting. Fig.5 shows high voltage characteristics at 0.95GeV. The obtained coefficients of horizontal kick were -0.1409 micro-rad/V(0.95GeV) and -0.1179 micro-rad/V(1.3GeV). The results of the coefficients in horizontal are about 10% deviated from the energy scale factor. The kick angle at usual operation was measured as 3.1mrad(0.95GeV) and 3.4mrad(1.3GeV), respectively. For vertical direction, a small kick angle was observed.

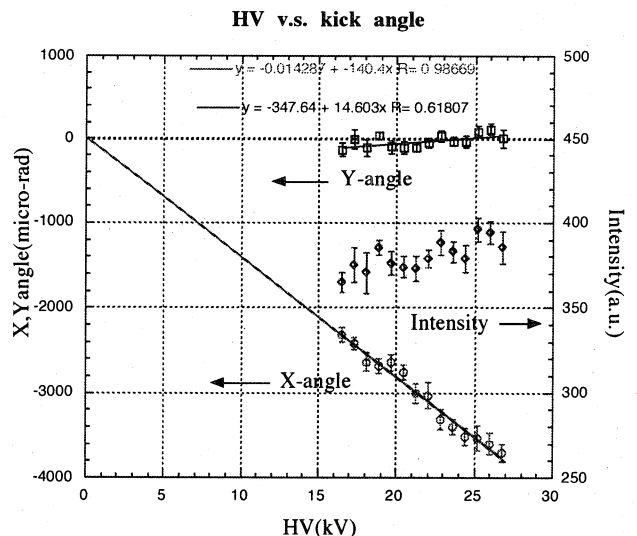

Fig. 5 High voltage characteristics

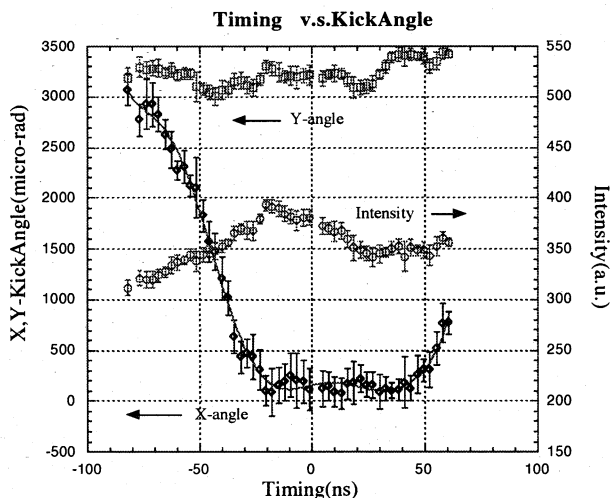

Fig. 6 Timing characteristics

The coefficients were 0.0146 micro-rad/V(0.95GeV) and -0.0462 micro-rad/V(1.3 GeV). The vertical kick angle was 10% and -40% of the horizontal kick angle. These results of the vertical kick was included the effect of the beam loss, the intensity was decreased at the low settings in Fig.5.

3.2 Timing characteristics

The effective kick angle at the time domain can be measured by changing the beam injection timing and measuring the kick angle of the beam. The beam injection timing at the kicker can be changed in 2.8ns step by a programmable delay module. The absolute kick angle couldn't be measured, because the orbit couldn't be measured at the off timing of the flattop of the pulse. The differences of the kick angles at the different injection timing settings near the flattop were measured. Fig.6 shows the injection timing characteristics at 0.95GeV. The flattop width within 200

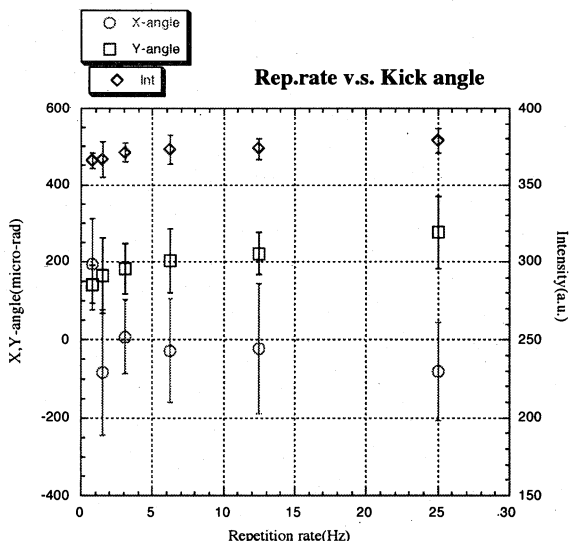

Fig. 7 Repetition rate characteristics

micro-rad was 67.2ns for 0.95GeV and 1.3GeV. This is enough wide for ATF 20 bunch injection. The kick angle at usual operation of the single bunch injection was measured as 0 nsec point. This timing is near the center of the flattop.

3.3 Repetition rate characteristics

The repetition of beam trigger can be selected 0.8, 1.5, 3.1, 6.2, 12.5 and 25Hz. The dependence of the kick angle on the repetition rate is plotted in Fig.7. There is no clear difference at each repetition except for 0.8Hz. The deviation at 0.8Hz comes from the operation condition of the thyatron. The thyatron are not enough stabilized at the low repetition rate.

4 SUMMARY

The injection kicker same type of the SLC NDR was installed and the characteristics were measured by using the beam. The kick angle at usual operation was 3.1mrad (0.95GeV) and 3.4mrad(1.3GeV), respectively. The design value is 5mrad. This deviation means that the injection orbit at the septum region goes off-center and there is a one of the reason of the beam loss. The pulse shape of the magnetic field has 67.2ns of the flattop region which is adequate for multi-bunch injection. At the case of the multi-bunch injection of 20 bunch, the flattop is required to 53.2ns.

5 ACKNOWLEDGMENTS

We would like to express our thanks to Professor K.Takata for his encouragement. We also wish to thank ATF operation group for their support.

REFERENCES

- [1] Ed. by F.Hinode, et al., "ATF Design Study Report", KEK Internal 95-4, June 1995
- [2] T.Mattison, et al., "Status of the SLC Damping Ring Kicker Systems", Proc. of IEEE Particle Acc. conf. 1991 pp2331-2333
- [3] T.Mattison, et al., "Operational experience with SLC Damping Ring Kicker Magnets", Proc. of IEEE Particle Acc. conf. 1991 pp2955-2957
- [4] A.R. Donaldson et al., "Kicker thyatron Experience from SLC", Proc. of IEEE Particle Acc. conf. 1991 pp3165-3167
- [5] T.Mattison, et al., "Fast and Reliable Kicker magnets for the SLC Damping Rings", Proc. of IEEE Particle Acc. conf. 1995 pp1915-1917